



# Greengate

## Passive Infrared (PIR) Single Relay Occupancy Sensing Wall Switch

# Installation Instructions



RoHS

Model # OSW-P-1001-MV

### General Information

- Read all instructions on both sides of this sheet first
- Install in accordance with ALL local codes

- For indoor use only

### Specifications

**Technology:** Passive Infrared (PIR)

**Electrical Ratings:**

120 VAC:

- Incandescent/Magnetic Low Voltage/Magnetic Ballast – Max. load: 15A, 1800W, 60 Hz
- LED/Compact Fluorescent/Electronic Low Voltage/Electronic Ballast – Max. load: 10A, 1200W, 60 Hz

Motor Load: ½ HP @ 125 VAC

277 VAC:

- Magnetic Low Voltage/Magnetic Ballast/LED/Compact Fluorescent/Electronic Low Voltage/Electronic Ballast – Max. Load: 8A, 2200W, 60 Hz

**No Minimum Load Requirement**

**Time Delays:** selectable 5 seconds/test, 5

minutes (factory default), 10, and 30 minutes

**Coverage:** Major motion – 1000 sq. ft.  
Minor motion – 300 sq. ft.

**Light Level Sensing:** 0 to 200 foot-candles

**Operating Environment:**

- Temperature: 32° F – 104° F (0° C – 40° C)
- Relative Humidity: 20% to 90%  
Non-condensing

**Housing:** Durable, injection molded housing.

Polycarbonate resin complies with UL94V0

**Size:** Mounting Plate/Strap Dimensions:

4.2" H x 1.8" W (106.5 mm x 46 mm)  
Product Housing Dimensions:  
2.87" H x 1.6" W x 1.42" D (72.8 mm x 40.7 mm x 36 mm)

**LED Indicators:** Green LED indicates load status and motion detection

### Coverage

The OSW-P-1001-MV is designed for offices up to 300 square feet. Coverage testing has been performed according to the NEMA WD7 Guideline.

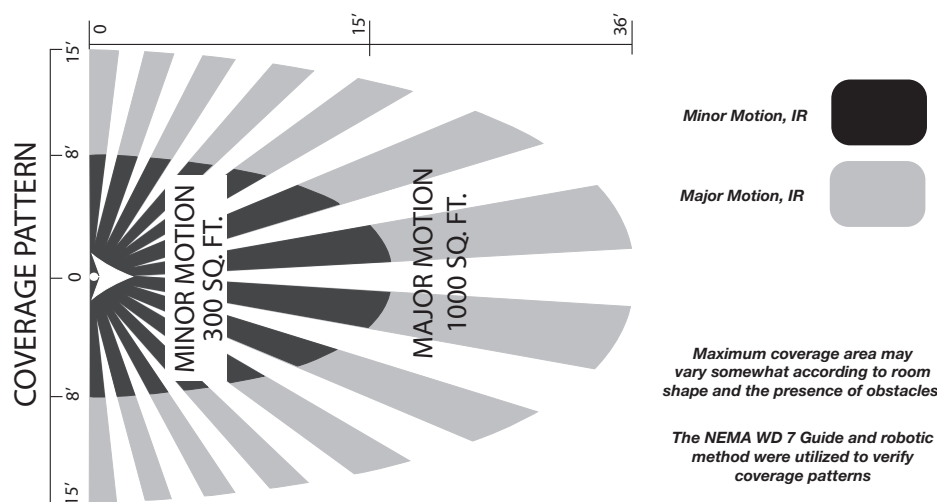

Maximum coverage area may vary somewhat according to room shape and the presence of obstacles.

**Location** When installing the OSW-P-1001-MV in a new junction box, choose the switch location carefully to provide optimum coverage of the occupied area. When replacing an existing Wall Switch, bear in mind that there must be a clear Line-of-sight between the sensor and the area to be covered. Avoid pointing the OSW-P-1001-MV directly into the hallway where it may detect passers-by.

### Installation

The OSW-P-1001-MV can be installed in any standard single gang box. It may be installed in the same manner as an ordinary Wall Switch.

- Wire the OSW-P-1001-MV as described in the wiring section.
- Mount the OSW-P-1001-MV in the junction box.

### Wiring

**CAUTION:** Before installing or performing any service on a Greengate system, the power **MUST** be turned OFF at the branch circuit breaker. According to NEC 240-83(d), if the branch circuit breaker is used as the main switch for a fluorescent lighting circuit, the circuit breaker should be marked "SWD". All installations should be in compliance with the National Electric Code and all state and local codes.

**NOTE REGARDING COMPACT FLUORESCENT LAMPS:** The life of some compact fluorescent lamps (CFLs) is shortened by frequent automatic or manual switching. Check with CFL and ballast manufacturer to determine the effects of cycling.

1. Make sure power is turned OFF at the branch circuit breaker.
2. Wire units as shown in wiring diagrams per applicable voltage requirements.
3. Mount unit to Wall Box.
4. Turn power back ON at the branch circuit breaker and wait 30 seconds for the unit to stabilize.
5. Make necessary adjustments. (See Checkout and Adjustments section)
6. Install Wall Switch plate.

DIAGRAM 1A: SENSOR IN ONE LOCATION

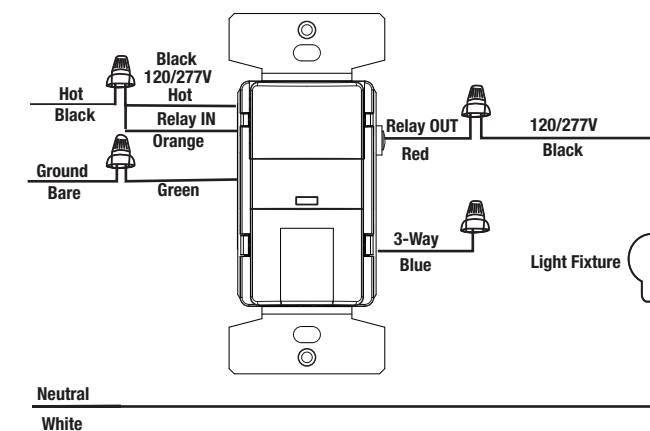
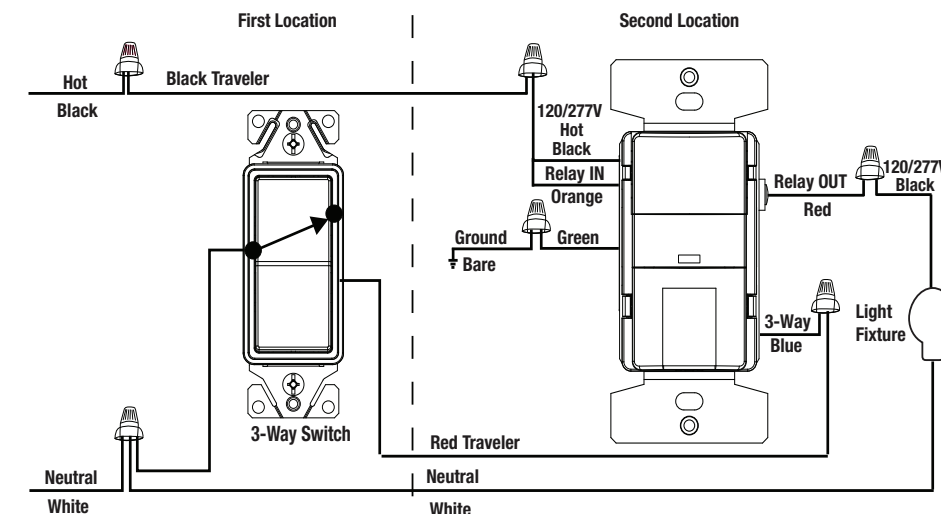
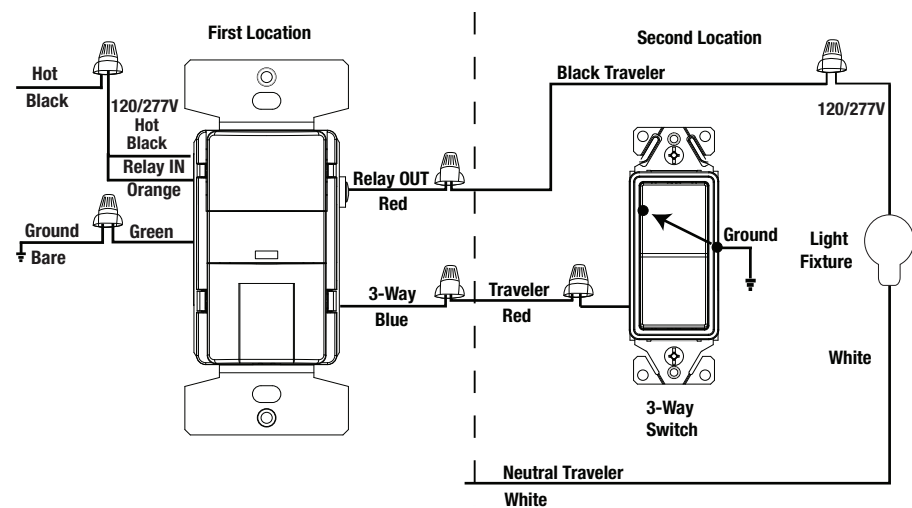

DIAGRAM 2A: SWITCH IN LOCATION WITH HOT WIRE



**DIAGRAM 2B: SENSOR ONE IN LOCATION WITH HOT WIRE**



**DIAGRAM 3: SENSORS IN BOTH LOCATIONS**

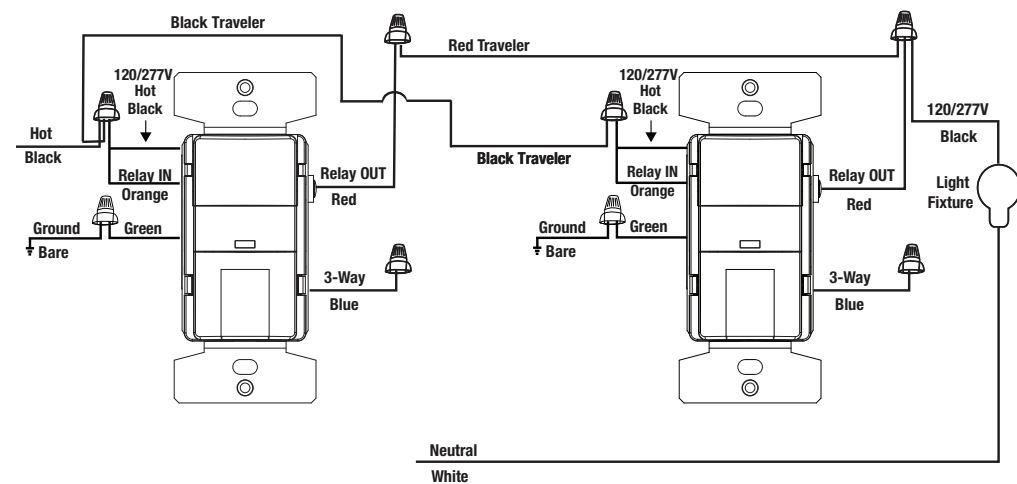

## Checkout and Adjustment

Adjustments should be made with the HVAC system ON so that the installer will be able to detect the effect of airflow on the operation of the OSW-P-1001-MV. Use only insulated tools to make adjustments. Immediately after applying power to the lighting circuit, wait approximately 30 seconds for the switch to power up and stabilize.

Verify that Power is ON by pushing the ON/OFF button. Lights should turn ON.

Coverage and sensitivity can be confirmed by watching the green (PIR) indicator LED on the front of the sensor, while moving around the room.

1. Walk around the room and monitor the LED.
2. Stand in different parts of the room and wave your hands. LED should only turn ON with each motion. (If LED does not turn ON, go to troubleshooting).

### Time Delay Adjustment:

1. Remove the button from the sensor by pressing in the hooks on the button, and then lift up on the button as shown in Figure 5.
2. Set the Time Delay using the dial on the right side by using a small Phillips head screwdriver. Align the arrow on the dial to the desired Time Delay (see Figure 4).
3. To allow the installer to quickly confirm that the sensor is functioning properly the Time Delay can be set to TEST. This will set the Time Delay to 5 seconds.
4. Replace the button by sliding it upward into the slots in the front housing and push down until the button hooks snap into place.

### Daylight Sensing Adjustment:

- The Daylight sensing feature prevents lights from turning ON when the room is adequately illuminated by natural light.
- NOTE - The factory setting for this adjustment is fully clockwise and permits motion detection to turn ON the lights regardless of the ambient light level in the room.
- Remove the ON/OFF Pushbutton to access the light level adjustment. See Fig. 5.
- This adjustment must be made when the light level in the room is at the desired level for the lights to turn ON.
- From the clockwise position, turn the dial on the left counter-clock-wise using a small Phillips screwdriver until the LED starts to flash. See Fig. 4.
- Step away from the sensor to allow the device to calibrate to the normal light level in the room. Do not obstruct the natural light. The calibration process starts when the LED and lights turn OFF, and will take approximately 15 seconds. After completion the lights will turn on.
- Replace the ON/OFF Pushbutton.

**FIGURE 4**

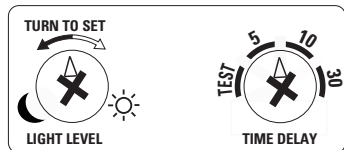

**FIGURE 5**

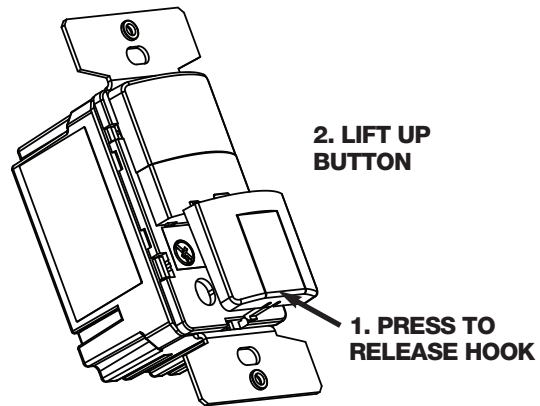

### Special Modes:

- **Vacancy Mode** – Press and hold the ON/OFF button for 5 seconds until the indicator LED blinks. Release the button while the LED is blinking. Repeat this procedure to restore to normal automatic activation.
- **ON/OFF Button Disable Mode** - Press and hold the ON/OFF button for 15 seconds until the LED indicator blinks for the third time (the LED will also blink at the 5 seconds and 10 seconds point) and then release the button while the LED is blinking. Repeat this procedure to restore normal operation.
- **Override Mode** - Press and hold for 10 seconds until LED blinks for the second time. Repeat this procedure to restore normal operation.

## Troubleshooting

Issue	Possible Causes	Suggestions
<b>Light does not automatically turn ON.</b>	Circuit breaker is turned OFF, or fuse is blown	Turn circuit breaker ON, or replace fuse
	Light bulb is defective	Replace Light bulb
	Poor connection	Verify all wiring connections
	Control may be wired incorrectly	Check wiring
	Daylight sensing prevents lights ON	Re-adjust daylight sensing level
<b>Light does not automatically turn OFF.</b>	Manual On mode selected	Set device to Automatic On mode.
	Motion is still present	Make sure there is no motion during the Time Delay period
	Time Delay has not expired	No action needed or shorten TIME DELAY
	Control may be wired incorrectly	Check wiring
<b>Lights Will Not Stay ON</b>	Switch is being triggered by air vent or other heat source	Move switch to the other switch location (if a 3-way), or determine the source triggering the switch, and alter the air flow.
	Motion is not detected	Create movement in front of the sensor for 5 seconds
<b>Remote switch does not work</b>	TIME control is set for too short a delay	Set switch TIME control to longer time period
	Control may be wired incorrectly	Check wiring
<b>If lights will not operate properly, call Technical Services at 1-800-553-3879</b>		

## Limited Warranty

All products manufactured by Cooper Lighting Solutions and identified with the Greengate brand are warranted to be free from defects in material and workmanship and shall conform to and perform in accordance with Seller's written specifications for a period of: Five (5) years from date of shipment for all occupancy sensors and Three (3) years from date of factory invoice for our hardware and software on Lighting Control Panels. We warranty all our standard relays for a period of 10 years from date of factory invoice. We guarantee the performance of our system to specifications or your money back. This warranty will be limited to the repair or replacement, at Seller's discretion, of any such goods found to be defective, upon their authorized return to Seller. This limited warranty does not apply if the goods have been damaged by accident, abuse, misuse, modification or misapplication, by damage during shipment or by improper service. There are no warranties, which extend beyond the hereinabove-limited warranty, INCLUDING, BUT NOT LIMITED TO, THE IMPLIED WARRANTY OF MERCHANTABILITY AND THE IMPLIED WARRANTY OF FITNESS. No employee, agent, dealer, or other person is authorized to give any warranties on behalf of the Seller or to assume for the Seller any other liability in connection with any of its goods except in writing and signed by the Seller. The Seller makes no representation that the goods comply with any present or future federal, state or local regulation or ordinance. Compliance is the Buyer's responsibility. The use of the Seller's goods should be in accordance with the provision of the National Electrical Code, UL and/or other industry or military standards that are pertinent to the particular end use. Installation or use not in accordance with these codes and standards could be hazardous.