

**DESCRIPTION**

A lampholder designed for use with Halogen PAR lamp technology. Front loading of the lamp allows for intuitive relamping. Available in white or black. Ideal for accent and display lighting applications

Catalog #	Type
Project	
Comments	
Prepared by	Date

**SPECIFICATION FEATURES**

**A...Electrical Quick Lock Adapter**

Lexan polycarbonate casing. Attaches electrically and mechanically anywhere along Power-Trac. Visual polarity line assures proper grounding. Two position conductor allows use in single circuit and either circuit of two circuit track.

**B...Arm**

Matching finish single arm allows lampholder to rotate 338° and adjust vertically from 0° to 90°.

**C...Lampholder Body**

Welded steel housing provides light weight and optimal heat dissipation.

**D...Swivel**

Swivel maintains tension to keep lampholder properly aimed.

**Listings**

UL/CSA listed for use with Halo and Lazer-by-Halo Track and track systems

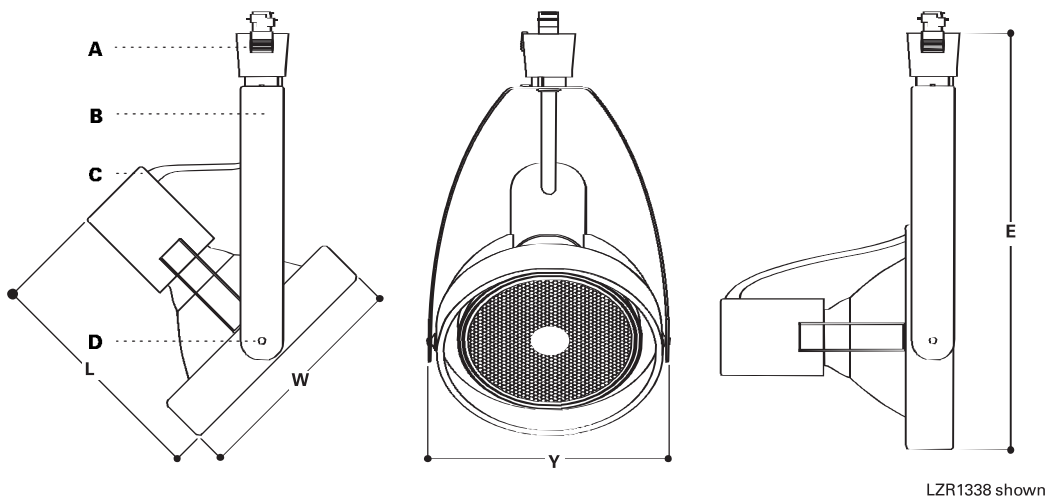

**LZR1320**



**LZR1330**



**LZR1338**

**ORDERING INFORMATION**

SAMPLE NUMBER: LZR1338P

Lampholders	Finishes	Accessories
LZR1320 LZR1330 LZR1338	P=Satin White MB=Satin Black	See below

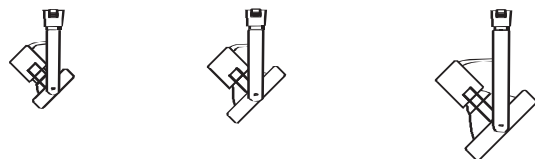

**LZR1320**

For use with:  
50W PAR20  
W=3 1/4" [83mm]  
L =3 7/8" [99mm]  
E =7" [178mm]  
Y =3 5/8" [92mm]

**LZR1330**

For use with:  
75W PAR30  
W=4 13/16" [123mm]  
L =4 1/4" [105mm]  
E =8 1/4" [207mm]  
Y =5 3/16" [132mm]

**LZR1338**

For use with:  
150W PAR38  
W=5 7/8" [150mm]  
L =6" [153mm]  
E =10 7/8" [277mm]  
Y =6 3/16" [157mm]

**Accessories**

L252MB Accessory Holder  
L400 Series 3 3/4" Color Filters  
L274MB Cube Cell Louver

**Accessories**

L352MB Accessory Holder  
L200 Series 4 11/16" Color Filters  
L275MB Cube Cell Louver

**LINE VOLTAGE  
FRONT LOADING GIMBAL  
LAMPHOLDERS**

Lazer by Halo

ACCESSORIES

**L252 Accessory Holder**

For use with LZR1330  
Lampholder to hold L400  
Series color filters and L274  
louver.

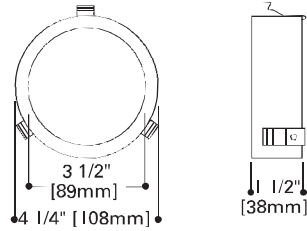

**L252 Media Holder**

**L352 Media Holder**

For use with LZR1338  
Lampholder to hold L200  
Series color filters and L275  
louver.

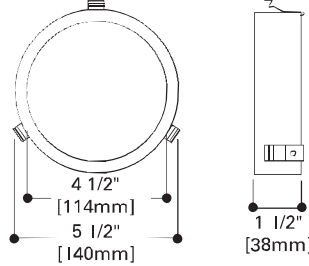

**L352 Media Holder**

**L200 Series Color Filters**

Glass Filters 4 11/16" (119mm)  
diameter. For use with L1830  
with L1976MB Barn Doors.

- L211=Medium Pink Color Filter
- L212=Warm Red Color Filter
- L214=Ultraviolet Filter
- L220=Daylight Blue Color Filter
- L221=Medium Blue Color Filter
- L231=Medium Amber Color Filter
- L241=Medium Green Color Filter

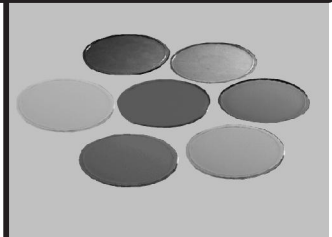
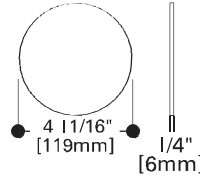

**L200 Color Filters**

**L400 Series Color Filters**

Glass Filters 3 3/4" (96mm)  
diameter. For use with L1830  
and L252 Media Holder.

- L411=Medium Pink Color Filter
- L412=Warm Red Color Filter
- L414=Ultraviolet Filter
- L420=Daylight Blue Color Filter
- L421=Medium Blue Color Filter
- L431=Medium Amber Color Filter
- L441=Medium Green Color Filter

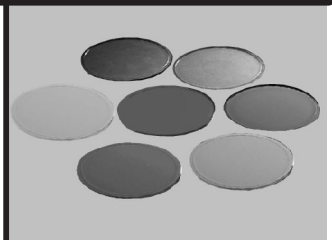
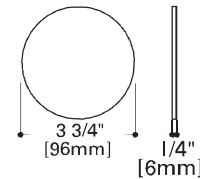

**L400 Color Filters**

**L274 Cube Cell Louver**

3 3/4" OD (96mm) . Black finish 1/2"  
cells for directing light and  
eliminating glare. For use with  
L1830 and L252MB Media Holder.

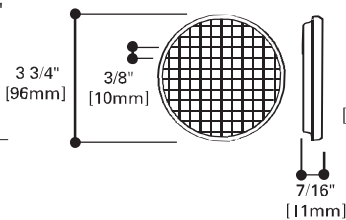

**L275 Cube Cell Louver**

4 3/4" OD (121mm) . Black finish  
1/2" cells for directing light and  
eliminating glare. For use with  
L1830 and L1976MB Barn Doors.

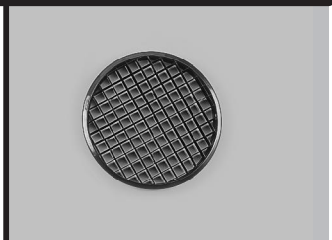
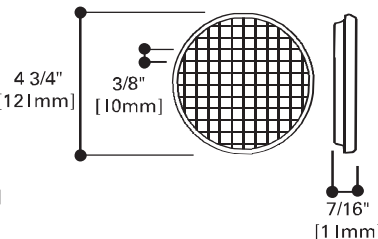

**Cube Louvers**

Note: Specifications and Dimensions subject to change without notice.