

DESCRIPTION

Recessed directional luminaire with 4 inch square aperture utilizing a low voltage MR16 tungsten-halogen lamp. Modular platform can be reconfigured from below the ceiling to accept a broad range of lamp modules and optical elements. Platform is suitable for 2x6 residential or shallow plenum commercial construction. Insulation must be kept 3" from top and sides of housing. Platform + module + element combination supports various lamp beam spreads for desired optical distribution with excellent light control and low aperture brightness.

Catalog #		Type
Project		
Comments		Date
Prepared By		

SPECIFICATION FEATURES

Frame

Galvanized steel plaster frame with integral bar hanger receivers. Setscrews provide positive horizontal locking.

Collar

Matte black steel collar adjusts vertically for 1/2" - 1" thick ceilings and can be rotated +/- 75° thru the aperture. Integral gun sights facilitate the use of guide strings or laser lines. Shipped with a paint overspray protector installed in the collar.

Lamp Module

Installed or removed thru the aperture or from the top at 0°, 90°, 180° and 270° positions. Hot aiming rotates 365°, tilts 45° and locks in position using #2 Philips screwdriver. Translating center beam optics aligns axis of lamp with aperture as lamp translates from nadir thru 45°.

Housing

Steel housing painted matte black for a visually dark interior. Removable hinged top allows for top access. All fasteners are captive.

Gaskets

Closed cell gaskets achieve restrictive airflow requirements without additional caulking.

Optical Element

Mousetrap type springs pull flange tight to ceiling. Light trap eliminates spill light at edge of flange and reflector. Available in self-flanged or metal trim ring versions. May also be installed rimless, using optional rimless adapter.

Bar Hangers

Captive preinstalled bar hangers adjusts from 8-1/2" to 24" wide; pass thru feature allows shortening without removal. Captive nail penetrates standard and engineered lumber. Mounting flange levels platform with ceiling. Integral clip attaches directly to t-bar.

Butterfly Bracket

Provides 3" of vertical adjustment and accepts 1/2" EMT, C channel or bar hangers.

Lower Reflector

Aluminum angle cut parabolic shielding prismatic is available in a wide range of semi specular Alzak® finishes. Corrugated Baffle: An optional embossed pattern that extends through the flange adds a subtle design element and reduces aperture brightness.

Junction Box

(7) 1/2" trade size pry outs, (3) integral clamps for non-metallic cable. Rated for (8) #12 thru branch circuits. Wago® type push wire connectors for field connections.

Thermal Protector

Self-resetting thermal protector protects against improper lamping and direct contact with insulation.

Transformer

Integral dual output toroidal magnetic transformer, 120V 50/60Hz input, 12V nominal 75VA maximum output. Separate output for circuits controlled by dimmers compensates for losses in dimmers, improves color temperature and lumen output.

Lamp Capsule

Ceramic GX5.3 lamp holder mounts to die cast aluminum heat sink to dissipate heat. Connects to the transformer with electrical quick connects. Accepts 2 lenses, filters, or optional lamp snoot.

Code Compliance

Thermally protected, IP labeled, cULus listed for damp locations and ASTM-E283 AIRTITE™.



**P406TAT
MA4MR
E4AA E4AACB**

**75W MR16
Tungsten-Halogen**

4 Inch Square Directional

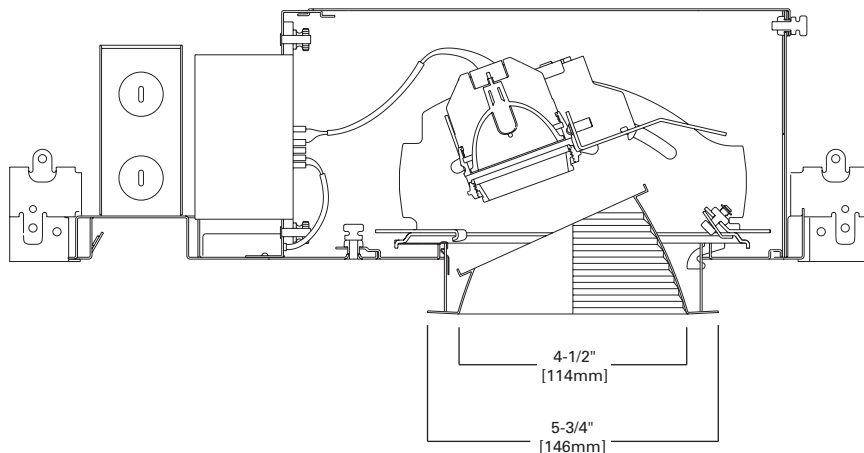
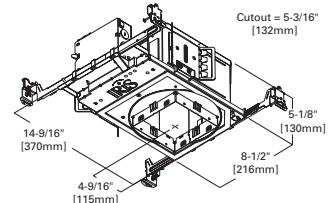

ENERGY DATA		
Lamp Wattage (Nominal)	Input Power (Watts)	Input Current (Amps)
20	21	0.17
35	37	.031
37	39	0.32
42	44	0.37
50	53	0.44
65	69	0.57
71	76	0.63
75	81	0.67

ORDERING INFORMATION: Complete unit consists of platform, lamp module and optical element.

Example: P406TAT + MA4MR + E4AAHSF

Platform	Lamp Module	Optical Element	Finish	Flange	Accessories
P406TAT = 4" Square Aperture Non-IC Housing P406TCP = 4" Square Aperture Non-IC Chicago Plenum Housing	MA4MR = MR16 Directional Lamp Module, 120V Input	E4AA = 4" Square Aperture Angle Cut Lower Shielding Prismaoid, Open E4AACB = 4" Square Aperture Corrugated Angle Cut Lower Shielding Prismaoid, Open	Alzak® Finishes LI = Specular Clear, Low Iridescence H = Semi-Specular Clear G = Gold WMH = Warm Haze WH = Wheat WHH = Wheat Haze GP = Graphite GPH = Graphite Haze K = Cognac KH = Cognac Haze CC = Chocolate CCH = Chocolate Haze B = Black Painted Finishes MB = Matte Black MW = Matte White W = Gloss White	[Blank] = Metal Trim Ring, Matte White SF = Self Flanged, Matte White Flange (SFWF not available with corrugated baffle) RL = Rimless, use with rimless adapter	RA4X4 = Rimless adapter for 4" optical elements PLR4X4 = Plaster lathing ring for rimless surfaces RLA4X4 = Rimless adapter for solid ceiling surfaces LSA16 = Matte black lamp snoot accessory L4X4HEX = Matte black hex cell louver MTR4MW = Metal trim ring, matte white MTR4MB = Metal trim ring, matte black MTR4SN = Metal trim ring, satin nickel MTR4TBZ = Metal trim ring, tuscan bronze L Series - Filter Media For MR16 lamps (See Accessories specification sheet)

PHOTOMETRICS

P406TAT MA4MR E4AA E4AACB

Trim: **E4AAH**
Lamp: **42MR16VNSP9**



0° Horizontal Aiming

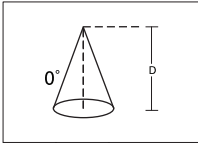

D	FC	Beam Diameter
8'	126	1.1'
9'	100	1.2'
10'	81	1.3'
13'	48	1.7'
15'	36	2.0'

30° Horizontal Footcandles

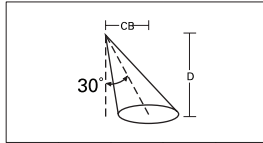

D	FC	L	W	CB
8'	85	1.7'	1.2'	4.6
9'	67	1.9'	1.3'	5.2
10'	54	2.1'	1.4'	5.8
13'	32	2.7'	1.9'	7.5
15'	24	3.1'	2.2'	8.7

30° Vertical Footcandles

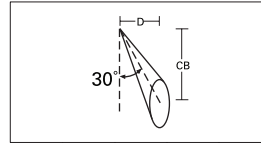

D	FC	L	W	CB
2'	290	1.1'	0.6'	3.5
3'	129	1.6'	0.8'	5.2
4'	72	2.1'	1.1'	6.9
5'	46	2.7'	1.4'	8.7
6'	32	3.2'	1.7'	10.4

45° Vertical Footcandles

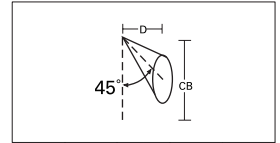

D	FC	L	W	CB
2'	776	0.6'	0.4'	2
3'	346	0.9'	0.6'	3
4'	194	0.2'	0.8'	4
5'	124	1.5'	1.0'	5
6'	86	1.8'	1.1'	6

Trim: **E4AAH**
Lamp: **50W MR16 IR SP10**



0° Horizontal Aiming

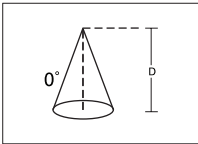

D	FC	Beam Diameter
8'	183	1.3'
9'	144	1.5'
10'	117	1.6'
13'	69	2.1'
15'	52	2.5'

30° Horizontal Footcandles

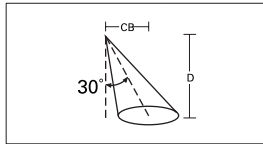

D	FC	L	W	CB
8'	109	2.0'	1.7'	4.6
9'	86	2.2'	1.9'	5.2
10'	70	2.5'	2.1'	5.8
13'	41	3.2'	2.7'	7.5
15'	31	3.7'	3.1'	8.7

30° Vertical Footcandles

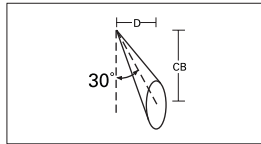

D	FC	L	W	CB
2'	390	1.3'	0.7'	3.5
3'	173	1.9'	1.0'	5.2
4'	98	2.6'	1.4'	6.9
5'	62	3.2'	1.7'	8.7
6'	43	3.8'	2.0'	10.4

45° Vertical Footcandles

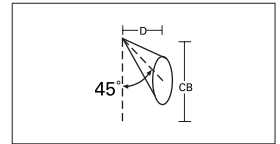

D	FC	L	W	CB
2'	963	0.7'	0.5'	2
3'	428	1.1'	0.8'	3
4'	241	1.4'	1.1'	4
5'	154	1.8'	1.3'	5
6'	107	2.1'	1.6'	6

Trim: **E4AAH**
Lamp: **65W MR16 40FL**



0° Horizontal Aiming

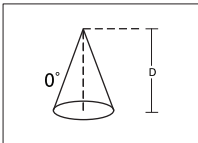

D	FC	Beam Diameter
8'	29	5.2'
9'	23	5.8'
10'	19	6.5'
13'	11	8.4'
15'	8	9.7'

30° Horizontal Footcandles

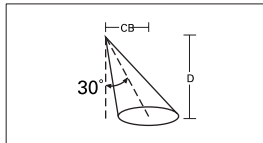

D	FC	L	W	CB
8'	21	5.5'	5.6'	4.6
9'	17	6.2'	6.3'	5.2
10'	13	6.9'	7.0'	5.8
13'	8	9.0'	9.0'	7.5
15'	6	10.4'	10.4'	8.7

30° Vertical Footcandles

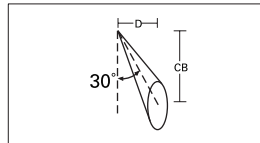

D	FC	L	W	CB
2'	121	2.0'	1.9'	3.5
3'	54	3.0'	2.8'	5.2
4'	30	4.0'	3.8'	6.9
5'	19	5.0'	4.7'	8.7
6'	13	6.0'	5.7'	10.4

45° Vertical Footcandles

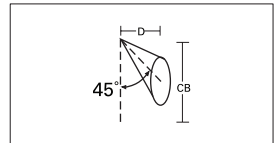

D	FC	L	W	CB
2'	201	1.6'	1.7'	2
3'	89	2.4'	2.6'	3
4'	50	3.2'	3.4'	4
5'	32	4.0'	4.3'	5
6'	22	4.8'	5.1'	6

Trim: **E4AAH**
Lamp: **71MR16 NFL**



0° Horizontal Plane

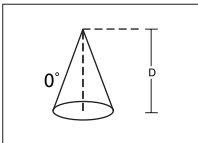

D	FC	Beam Diameter
8'	57	3.4'
9'	45	3.8'
10'	37	4.2'
13'	22	5.5'
15'	16	6.3'

30° Horizontal Plane

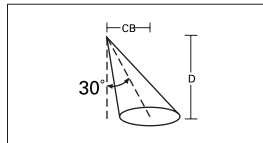

D	FC	L	W	CB
8'	39	3.9'	3.5'	4.6
9'	31	4.4'	4.0'	5.2
10'	25	4.9'	4.4'	5.8
13'	15	6.3'	5.8'	7.5
15'	11	7.3'	6.6'	8.7

30° Vertical Plane

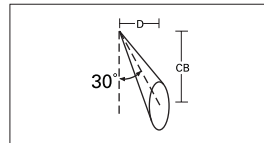

D	FC	L	W	CB
2'	165	2.1'	1.3'	3.5
3'	73	3.1'	2.0'	5.2
4'	41	4.1'	2.7'	6.9
5'	26	5.1'	3.3'	8.7
6'	18	6.2'	4.0'	10.4

45° Vertical Plane

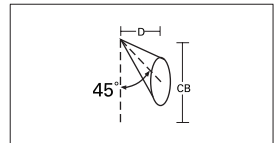

D	FC	L	W	CB
2'	357	1.3'	1.0'	2
3'	159	2.0'	1.6'	3
4'	89	2.6'	2.1'	4
5'	57	3.3'	2.6'	5
6'	40	3.9'	3.1'	6