



Höchste Lichtqualität mit bester Farbwiedergabe und perfekte Lebensdauer

MASTER LEDspot & Value MR16/MR11 Niedervolt- Reflektorlampen

Ersetzen Sie ihre alten Halogen-Niedervolt-Reflektorlampen und sparen Sie bares Geld. MASTER LEDspot MR16/MR11 haben mit ihren kompakten Abmessungen die perfekte Passform als Ersatz für Halogen-Reflektorlampen und verbrauchen bis zu 80% weniger Energie.

Vorteile

- Value Reihe: 25.000 Stunden Nutzlebensdauer
- ExpertColor Reihe: 40.000 Stunden Nutzlebensdauer und Farbwiedergabe bis zu Ra92

Merkmale

- Beste Farbwiedergabe
- 25.000 (Value) bis 40.000 (ExpertColor) Stunden Nutzlebensdauer
- Viele Typen an von Philips empfohlenen Dimmern dimmbar

Anwendung

- Für Akzent- und Allgemeinbeleuchtung in Hotels, Restaurants, Bars, Cafés und Museen
- Nur in offenen/belüfteten Leuchten verwenden
- Einzusetzen im Innenbereich bei Temperaturen von -20 bis +45°C

MASTER LEDspot & Value MR16/MR11 Niedervolt-Reflektorlampen

Hinweise

- Nicht für den Einsatz in sehr luftfeuchter Umgebung geeignet (z.B. über der Dusche)
- Nicht für elektronische Schalter geeignet
- Max. 80% Luftfeuchtigkeit
- Min. 10 mm Luftraum beim Deckeneinbau zur Gewährleistung der konstanten Wärmeableitung

Versions



LEDspots MAS SLR 2 MR11 GU4



LEDspots MAS MR16 GU5,3 1

Abmessungsskizzen

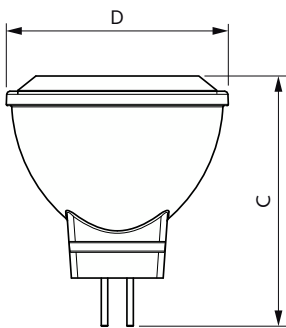
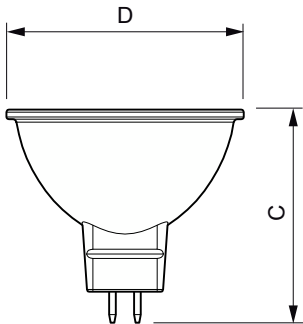

Product	D	C
MAS LED SPOT VLE D 7.5-50W MR16 927 36D	50,5 mm	45,5 mm
MAS LED SPOT VLE D 7.5-50W MR16 927 60D	50,5 mm	45,5 mm
MAS LED SPOT VLE D 7.5-50W MR16 930 36D	50,5 mm	45,5 mm
MAS LED SPOT VLE D 7.5-50W MR16 930 60D	50,5 mm	45,5 mm
MAS LED SPOT VLE D 7.5-50W MR16 940 36D	50,5 mm	45,5 mm
MAS LED SPOT VLE D 7.5-50W MR16 940 60D	50,5 mm	45,5 mm
MAS LED spot VLE D 5.8-35W MR16 927 36D	50,5 mm	45,5 mm
MAS LED spot VLE D 5.8-35W MR16 927 60D	50,5 mm	45,5 mm
MAS LED spot VLE D 5.8-35W MR16 930 36D	50,5 mm	45,5 mm
MAS LED spot VLE D 5.8-35W MR16 930 60D	50,5 mm	45,5 mm
MAS LED spot VLE D 5.8-35W MR16 940 36D	50,5 mm	45,5 mm
MAS LED spot VLE D 5.8-35W MR16 940 60D	50,5 mm	45,5 mm
MAS LEDspotLV DimTone 5.8-35W MR16 36D	50,5 mm	45,5 mm

Product	D	C
MAS LEDspotLV 3.5-20W 827 MR11 24D	35,1 mm	39,5 mm

MASTER LEDspot & Value MR16/MR11 Niedervolt-Reflektorlampen

Allgemeine Informationen

Schaltzyklus 50.000

Lichttechnische Daten

Restlichtstrom am Ende der Nennlebensdauer (Nom.) 70 %

Betrieb und Elektrik

Eingangsfrequenz - Hz

Netzfrequenz - Hz

Startzeit (Nom) 0,5 s

Allgemeine Informationen

Order Code	Full Product Name	Socket	Nennlebensdauer	Order Code	Full Product Name	Socket	Nennlebensdauer
30718600	MASTER LED spot VLE D 5.8-35W MR16 927 36D	GU5.3	25.000 Stunde(n)	30732200	MASTER LED SPOT VLE D 7.5-50W MR16 927 36D	GU5.3	25.000 Stunde(n)
30720900	MASTER LED spot VLE D 5.8-35W MR16 930 36D	GU5.3	25.000 Stunde(n)	30734600	MASTER LED SPOT VLE D 7.5-50W MR16 930 36D	GU5.3	25.000 Stunde(n)
30722300	MASTER LED spot VLE D 5.8-35W MR16 940 36D	GU5.3	25.000 Stunde(n)	30736000	MASTER LED SPOT VLE D 7.5-50W MR16 940 36D	GU5.3	25.000 Stunde(n)
30724700	MASTER LED spot VLE D 5.8-35W MR16 927 60D	GU5.3	25.000 Stunde(n)	35990100	MASTER LEDspotLV 3.5-20W 827 MR11 24D	GU4	40.000 Stunde(n)
30726100	MASTER LED spot VLE D 5.8-35W MR16 930 60D	GU5.3	25.000 Stunde(n)	30738400	MASTER LED SPOT VLE D 7.5-50W MR16 927 60D	GU5.3	25.000 Stunde(n)
30728500	MASTER LED spot VLE D 5.8-35W MR16 940 60D	GU5.3	25.000 Stunde(n)	30740700	MASTER LED SPOT VLE D 7.5-50W MR16 930 60D	GU5.3	25.000 Stunde(n)
30730800	MASTER LEDspotLV DimTone 5.8-35W MR16 36D	GU5.3	25.000 Stunde(n)	30742100	MASTER LED SPOT VLE D 7.5-50W MR16 940 60D	GU5.3	25.000 Stunde(n)

Lichttechnische Daten

Order Code	Full Product Name	Ausstrahlungswinkel (Nom)	Ähnlichste		Farbwiedergabeindex		
			Farbtemperatur (Nom)	(CRI)	Farbcode	Lichtstrom	Lichtstärke (Nom)
30718600	MASTER LED spot VLE D 5.8-35W MR16 927 36D	36 Grad	2700 K	90	927	450 lm	1.300 cd
30720900	MASTER LED spot VLE D 5.8-35W MR16 930 36D	36 Grad	3000 K	90	930	460 lm	1.300 cd
30722300	MASTER LED spot VLE D 5.8-35W MR16 940 36D	36 Grad	4000 K	90	940	490 lm	1.200 cd
30724700	MASTER LED spot VLE D 5.8-35W MR16 927 60D	60 Grad	2700 K	90	927	450 lm	600 cd
30726100	MASTER LED spot VLE D 5.8-35W MR16 930 60D	60 Grad	3000 K	90	930	460 lm	600 cd
30728500	MASTER LED spot VLE D 5.8-35W MR16 940 60D	60 Grad	4000 K	90	940	490 lm	550 cd
30730800	MASTER LEDspotLV DimTone 5.8-35W MR16 36D	36 Grad	2200 K	90	922-927	345 lm	800 cd
30732200	MASTER LED SPOT VLE D 7.5-50W MR16 927 36D	36 Grad	2700 K	90	927	621 lm	1.600 cd
30734600	MASTER LED SPOT VLE D 7.5-50W MR16 930 36D	36 Grad	3000 K	90	930	630 lm	1.600 cd

MASTER LEDspot & Value MR16/MR11 Niedervolt-Reflektorlampen

Order Code	Full Product Name	Ausstrahlungswinkel (Nom)	Ähnlichste	Farbwiedergabeindex	Farbcode	Lichtstrom	Lichtstärke (Nom)
			Farbtemperatur (Nom)	(CRI)			
30736000	MASTER LED SPOT VLE D 7.5-50W MR16 940 36D	36 Grad	4000 K	90	940	660 lm	1500 cd
35990100	MASTER LEDspotLV 3.5-20W 827 MR11 24D	24 Grad	2700 K	80	827	200 lm	1.000 cd
30738400	MASTER LED SPOT VLE D 7.5-50W MR16 927 60D	60 Grad	2700 K	90	927	621 lm	750 cd
30740700	MASTER LED SPOT VLE D 7.5-50W MR16 930 60D	60 Grad	3000 K	90	930	630 lm	800 cd
30742100	MASTER LED SPOT VLE D 7.5-50W MR16 940 60D	60 Grad	4000 K	90	940	660 lm	770 cd

Betrieb und Elektrik

Order Code	Full Product Name	Systemleistung	Äquivalente
			Leistung
30718600	MASTER LED spot VLE D 5.8-35W MR16 927 36D	5,8 W	35 W
30720900	MASTER LED spot VLE D 5.8-35W MR16 930 36D	5,8 W	35 W
30722300	MASTER LED spot VLE D 5.8-35W MR16 940 36D	5,8 W	35 W
30724700	MASTER LED spot VLE D 5.8-35W MR16 927 60D	5,8 W	35 W
30726100	MASTER LED spot VLE D 5.8-35W MR16 930 60D	5,8 W	35 W
30728500	MASTER LED spot VLE D 5.8-35W MR16 940 60D	5,8 W	35 W
30730800	MASTER LEDspotLV DimTone 5.8-35W MR16 36D	5,8 W	35 W

Order Code	Full Product Name	Systemleistung	Äquivalente
			Leistung
30732200	MASTER LED SPOT VLE D 7.5-50W MR16 927 36D	7,5 W	50 W
30734600	MASTER LED SPOT VLE D 7.5-50W MR16 930 36D	7,5 W	50 W
30736000	MASTER LED SPOT VLE D 7.5-50W MR16 940 36D	7,5 W	50 W
35990100	MASTER LEDspotLV 3.5-20W 827 MR11 24D	3,5 W	20 W
30738400	MASTER LED SPOT VLE D 7.5-50W MR16 927 60D	7,5 W	50 W
30740700	MASTER LED SPOT VLE D 7.5-50W MR16 930 60D	7,5 W	50 W
30742100	MASTER LED SPOT VLE D 7.5-50W MR16 940 60D	7,5 W	50 W

Temperatur

Order Code	Full Product Name	Gehäusetemperatur (Nom)
30718600	MASTER LED spot VLE D 5.8-35W MR16 927 36D	85 °C
30720900	MASTER LED spot VLE D 5.8-35W MR16 930 36D	85 °C
30722300	MASTER LED spot VLE D 5.8-35W MR16 940 36D	85 °C
30724700	MASTER LED spot VLE D 5.8-35W MR16 927 60D	85 °C
30726100	MASTER LED spot VLE D 5.8-35W MR16 930 60D	85 °C
30728500	MASTER LED spot VLE D 5.8-35W MR16 940 60D	85 °C
30730800	MASTER LEDspotLV DimTone 5.8-35W MR16 36D	88 °C

Order Code	Full Product Name	Gehäusetemperatur (Nom)
30732200	MASTER LED SPOT VLE D 7.5-50W MR16 927 36D	95 °C
30734600	MASTER LED SPOT VLE D 7.5-50W MR16 930 36D	95 °C
30736000	MASTER LED SPOT VLE D 7.5-50W MR16 940 36D	95 °C
35990100	MASTER LEDspotLV 3.5-20W 827 MR11 24D	85 °C
30738400	MASTER LED SPOT VLE D 7.5-50W MR16 927 60D	95 °C
30740700	MASTER LED SPOT VLE D 7.5-50W MR16 930 60D	95 °C
30742100	MASTER LED SPOT VLE D 7.5-50W MR16 940 60D	95 °C

Lichtregelung und Dimmen

MASTER LEDspot & Value MR16/MR11 Niedervolt-Reflektorlampen

Order Code	Full Product Name	Dimmbar
30718600	MASTER LED spot VLE D 5.8-35W MR16 927 36D	Nur mit Spezial-Dimmern
30720900	MASTER LED spot VLE D 5.8-35W MR16 930 36D	Nur mit Spezial-Dimmern
30722300	MASTER LED spot VLE D 5.8-35W MR16 940 36D	Nur mit Spezial-Dimmern
30724700	MASTER LED spot VLE D 5.8-35W MR16 927 60D	Nur mit Spezial-Dimmern
30726100	MASTER LED spot VLE D 5.8-35W MR16 930 60D	Nur mit Spezial-Dimmern
30728500	MASTER LED spot VLE D 5.8-35W MR16 940 60D	Nur mit Spezial-Dimmern
30730800	MASTER LEDspotLV DimTone 5.8-35W MR16 36D	Nur mit Spezial-Dimmern

Order Code	Full Product Name	Dimmbar
30732200	MASTER LED SPOT VLE D 7.5-50W MR16 927 36D	Nur mit Spezial-Dimmern
30734600	MASTER LED SPOT VLE D 7.5-50W MR16 930 36D	Nur mit Spezial-Dimmern
30736000	MASTER LED SPOT VLE D 7.5-50W MR16 940 36D	Nur mit Spezial-Dimmern
35990100	MASTER LEDspotLV 3.5-20W 827 MR11 24D	Nein
30738400	MASTER LED SPOT VLE D 7.5-50W MR16 927 60D	Nur mit Spezial-Dimmern
30740700	MASTER LED SPOT VLE D 7.5-50W MR16 930 60D	Nur mit Spezial-Dimmern
30742100	MASTER LED SPOT VLE D 7.5-50W MR16 940 60D	Nur mit Spezial-Dimmern

Mechanik und Gehäuse

Order Code	Full Product Name	Kolbenform
30718600	MASTER LED spot VLE D 5.8-35W MR16 927 36D	MR16
30720900	MASTER LED spot VLE D 5.8-35W MR16 930 36D	MR16
30722300	MASTER LED spot VLE D 5.8-35W MR16 940 36D	MR16
30724700	MASTER LED spot VLE D 5.8-35W MR16 927 60D	MR16
30726100	MASTER LED spot VLE D 5.8-35W MR16 930 60D	MR16
30728500	MASTER LED spot VLE D 5.8-35W MR16 940 60D	MR16
30730800	MASTER LEDspotLV DimTone 5.8-35W MR16 36D	MR16

Order Code	Full Product Name	Kolbenform
30732200	MASTER LED SPOT VLE D 7.5-50W MR16 927 36D	MR16
30734600	MASTER LED SPOT VLE D 7.5-50W MR16 930 36D	MR16
30736000	MASTER LED SPOT VLE D 7.5-50W MR16 940 36D	MR16
35990100	MASTER LEDspotLV 3.5-20W 827 MR11 24D	MR11
30738400	MASTER LED SPOT VLE D 7.5-50W MR16 927 60D	MR16
30740700	MASTER LED SPOT VLE D 7.5-50W MR16 930 60D	MR16
30742100	MASTER LED SPOT VLE D 7.5-50W MR16 940 60D	MR16

Genehmigung und Anwendung

Order Code	Full Product Name	Energieverbrauch kWh/ 1.000 Std.
30718600	MASTER LED spot VLE D 5.8-35W MR16 927 36D	6 kWh
30720900	MASTER LED spot VLE D 5.8-35W MR16 930 36D	6 kWh
30722300	MASTER LED spot VLE D 5.8-35W MR16 940 36D	6 kWh
30724700	MASTER LED spot VLE D 5.8-35W MR16 927 60D	6 kWh
30726100	MASTER LED spot VLE D 5.8-35W MR16 930 60D	6 kWh
30728500	MASTER LED spot VLE D 5.8-35W MR16 940 60D	6 kWh
30730800	MASTER LEDspotLV DimTone 5.8-35W MR16 36D	6 kWh
30732200	MASTER LED SPOT VLE D 7.5-50W MR16 927 36D	8 kWh
30734600	MASTER LED SPOT VLE D 7.5-50W MR16 930 36D	8 kWh
30736000	MASTER LED SPOT VLE D 7.5-50W MR16 940 36D	8 kWh
35990100	MASTER LEDspotLV 3.5-20W 827 MR11 24D	4 kWh

Order Code	Full Product Name	Energieverbrauch kWh/ 1.000 Std.
30738400	MASTER LED SPOT VLE D 7.5-50W MR16 927 60D	8 kWh
30740700	MASTER LED SPOT VLE D 7.5-50W MR16 930 60D	8 kWh
30742100	MASTER LED SPOT VLE D 7.5-50W MR16 940 60D	8 kWh

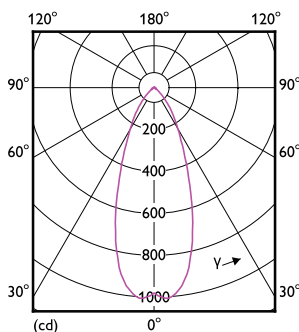

MASTER LEDspot & Value MR16/MR11 Niedervolt-Reflektorlampen

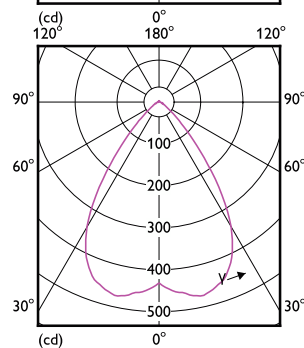
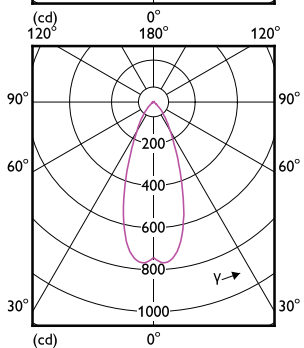
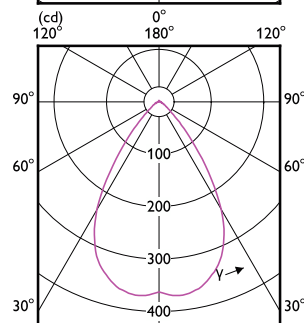
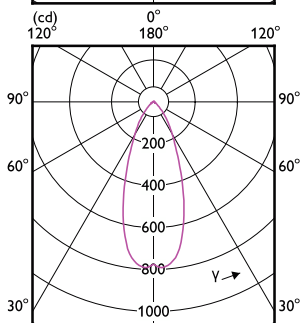
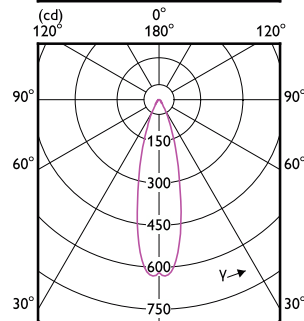
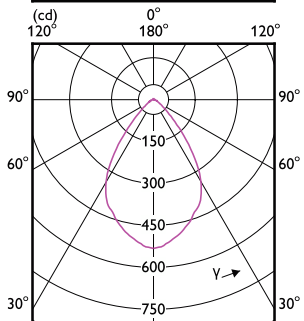
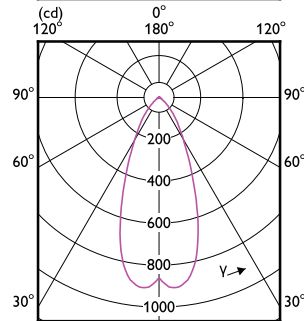
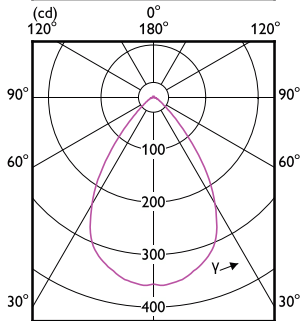
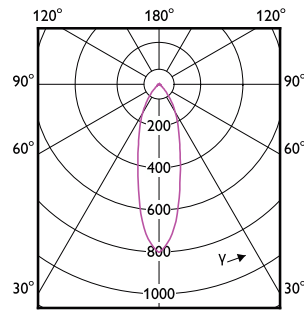
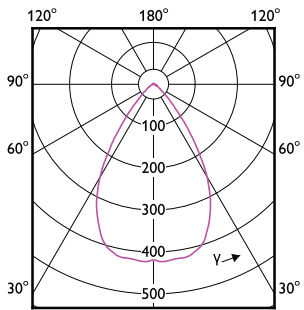

MASTER LEDspot & Value MR16/MR11 Niedervolt-Reflektorlampen

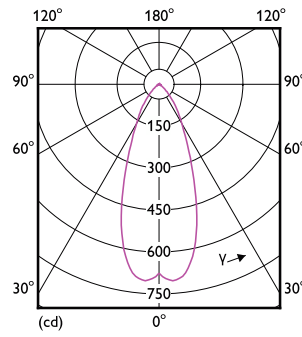
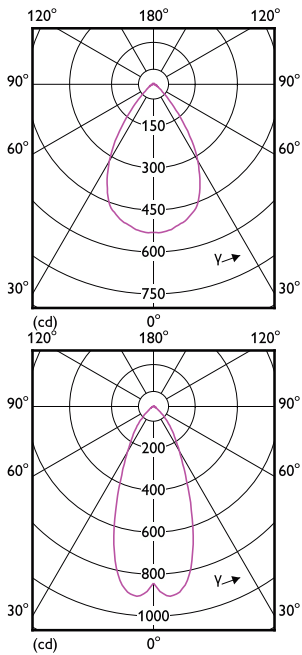

Accent Diagrams

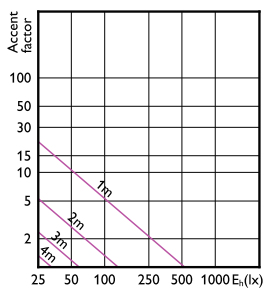

Accent Diagram - MAS LED SPOT VLE D
7.5-50W MR16 927 60D

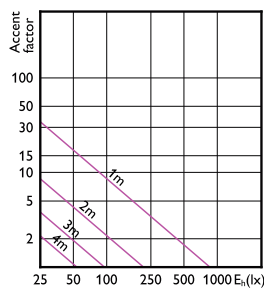

Accent Diagram - MAS LED SPOT VLE D
7.5-50W MR16 930 36D

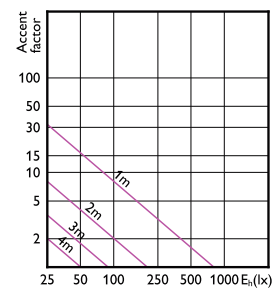

Accent Diagram - MAS LEDspotLV DimTone
5.8-35W MR16 36D

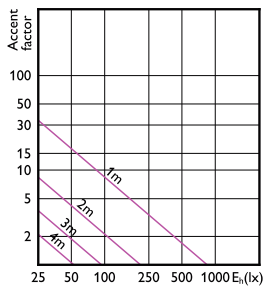

Accent Diagram - MAS LED SPOT VLE D
7.5-50W MR16 940 36D

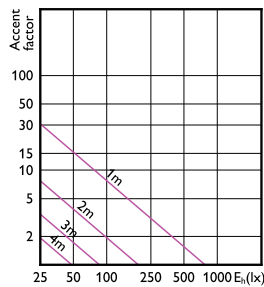

Accent Diagram - MAS LED spot VLE D 5.8-35W
MR16 940 36D

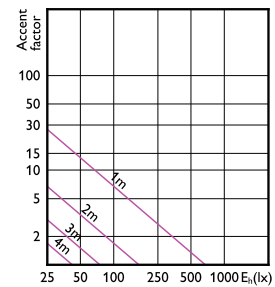

Accent Diagram - MAS LED spot VLE D 5.8-35W
MR16 927 36D

MASTER LEDspot & Value MR16/MR11 Niedervolt-Reflektorlampen

Accent Diagrams

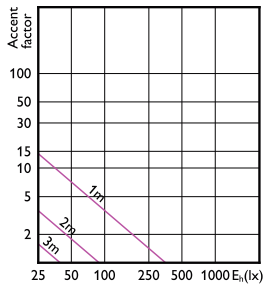

Accent Diagram - MAS LED spot VLE D 5.8-35W
MR16 930 60D

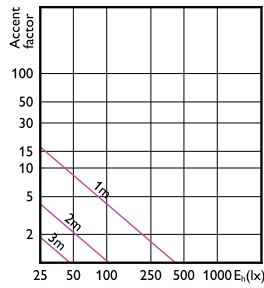

Accent Diagram - MAS LED spot VLE D 5.8-35W
MR16 940 60D

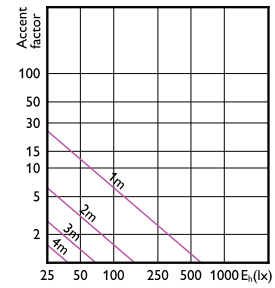

Accent Diagram - MAS LEDspotLV 3.5-20W 827
MR11 24D

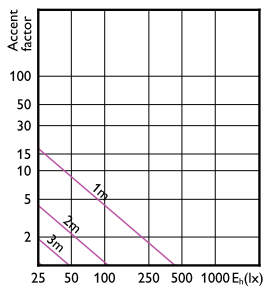

Accent Diagram - MAS LED SPOT VLE D
7.5-50W MR16 930 60D

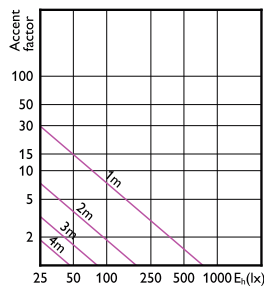

Accent Diagram - MAS LED spot VLE D 5.8-35W
MR16 930 36D

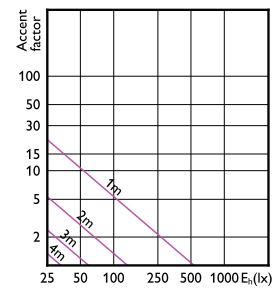

Accent Diagram - MAS LED SPOT VLE D
7.5-50W MR16 940 60D

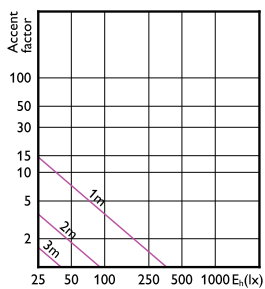

Accent Diagram - MAS LED spot VLE D 5.8-35W
MR16 927 60D

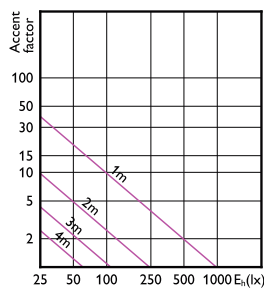

Accent Diagram - MAS LED SPOT VLE D
7.5-50W MR16 927 36D

MASTER LEDspot & Value MR16/MR11 Niedervolt-Reflektorlampen

Beam Diagrams

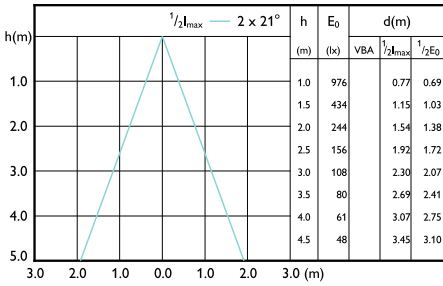

Beam diagram - MAS LED SPOT VLE D 7.5-50W MR16 927 36D

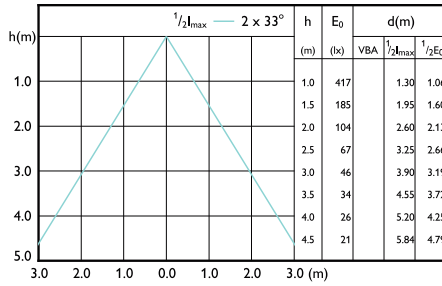

Beam diagram - MAS LED spot VLE D 5.8-35W MR16 940 60D

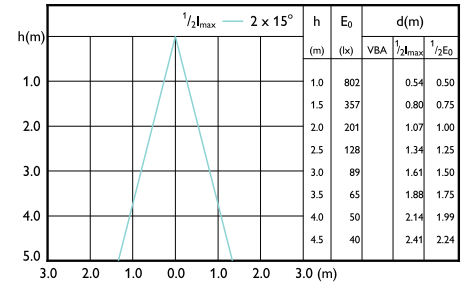

Beam diagram - MAS LEDspotLV DimTone 5.8-35W MR16 36D

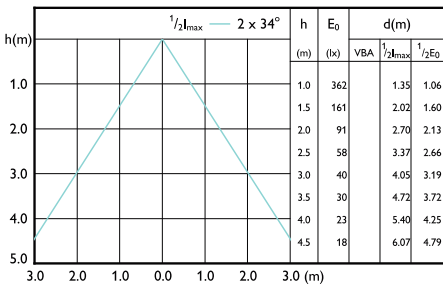

Beam diagram - MAS LED spot VLE D 5.8-35W MR16 927 60D

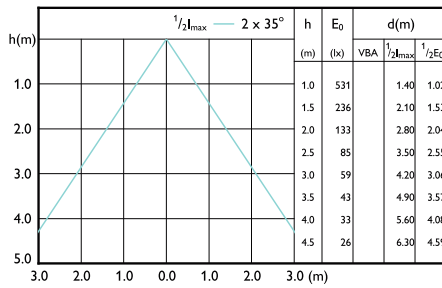

Beam diagram - MAS LED SPOT VLE D 7.5-50W MR16 940 60D

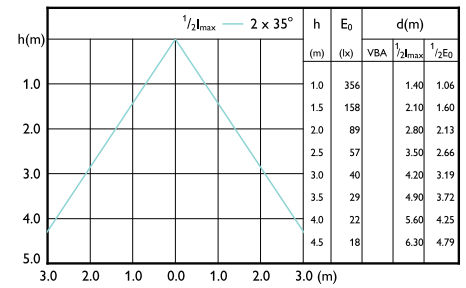

Beam diagram - MAS LED spot VLE D 5.8-35W MR16 930 60D

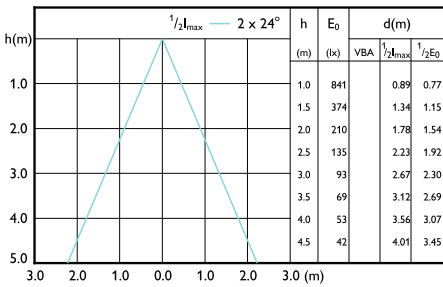

Beam diagram - MAS LED SPOT VLE D 7.5-50W MR16 940 36D

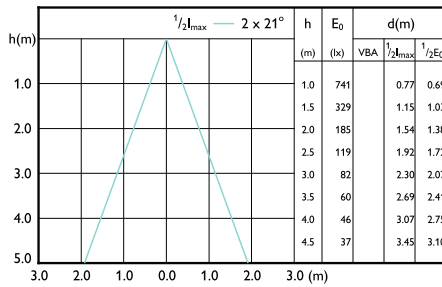

Beam diagram - MAS LED spot VLE D 5.8-35W MR16 930 36D

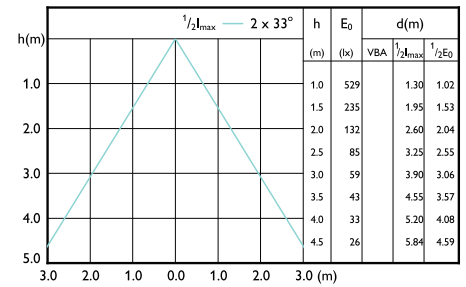

Beam diagram - MAS LED SPOT VLE D 7.5-50W MR16 927 60D

MASTER LEDspot & Value MR16/MR11 Niedervolt-Reflektorlampen

Beam Diagrams

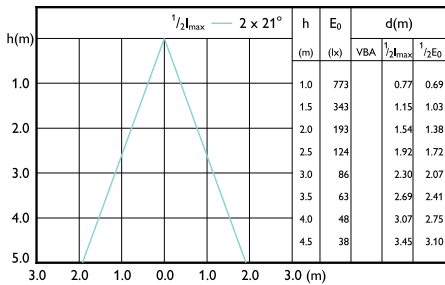

Beam diagram - MAS LED spot VLE D 5.8-35W MR16 940 36D

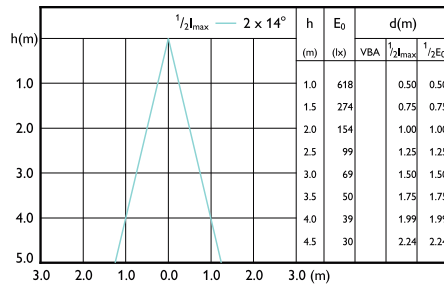

Beam diagram - MAS LEDspotLV 3.5-20W 827 MR11 24D

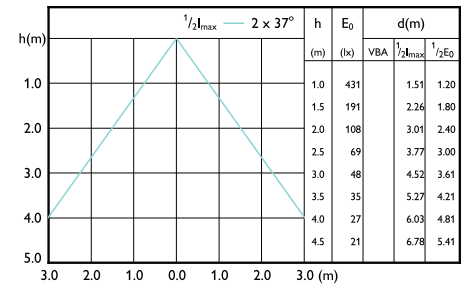

Beam diagram - MAS LED SPOT VLE D 7.5-50W MR16 930 60D

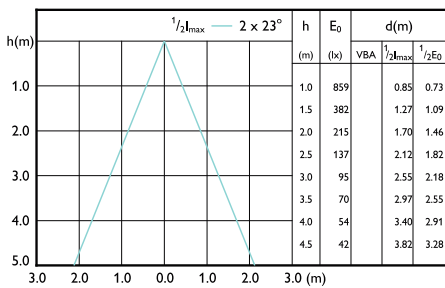

Beam diagram - MAS LED SPOT VLE D 7.5-50W MR16 930 36D

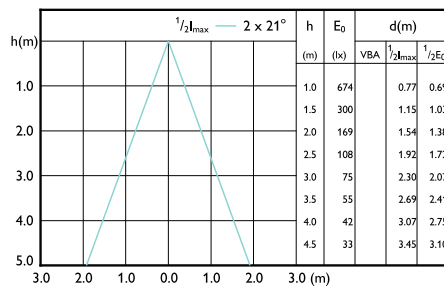

Beam diagram - MAS LED spot VLE D 5.8-35W MR16 927 36D

