



Philips Luma gen2: The standard in road lighting redefined, with UltraEfficient performance options

Luma gen2

The Philips Luma family is designed to deliver flexible, highly efficient, and sustainable lighting that adapts to the dynamic needs of every city. Luma gen2 preserves the distinctive design characteristics of the first generation while adding the benefits of the latest technology, including a future-proof System Ready architecture, a new LEDgine performance extension, and an optical platform that ensures best-in-class lighting performance in a broad range of applications. Luma gen2 also offers improved serviceability. Installation is easy and fast, and Service tag gives you access to all relevant specs and product documentation onsite. The cable feed-through offers easy, top-down, tool-less access to the luminaire's gear components. Because Luma gen2 is System Ready, you can pair it with connected lighting management systems such as Interact, or with existing and future sensor innovations. Luma gen2 has been developed to optimize and simplify repairs and maintenance with a plug-and-play GearFlex module containing all electrical components in an easy-to-handle and accessible box inside the housing. Because sustainability is our focus, the GearFlex module uses post-industrial recycled material, The white frame around the LED engine uses post-industrial recycled material, and our product packaging minimizes plastic waste. The product can be disassembled in only a few steps at end of life. As a company conscious of the impact of light on the environment and biodiversity, we equipped Luma gen2 luminaires with dedicated light recipes that help to protect ecosystems for bats and preserve the dark night sky.

Luma gen2

Benefits

- Best-in-class efficiency and light performance in a broad range of applications
- Ease of repairs and maintenance via a dedicated GearFlex module
- Easy disassembly at end of life
- Future-ready thanks to the SR (System Ready) socket
- Luminaire is equipped with dedicated light recipes that help to maintain optimal ecosystems for bats, preserve the dark night sky, and reduce light pollution
- Equipped with Service tag, a QR-based identification system that makes each luminaire uniquely identifiable and provides maintenance, installation, and spare parts information on-site

Features

- Dedicated GearFlex module enabling faster, safer, and tool-less maintenance
- Post-industrial recycled plastic material used in the GearFlex module and the white frame around the LED compartment
- >85% recyclable aluminum content
- Cable feed-through for easy installation
- Ready to be connected to Interact connected lighting management systems
- Ready to be paired with third-party lighting management systems and sensors
- Tilt with precision of 2.5 degrees
- Efficacy up to 200 lm /W for selected configurations
- Choice of 40+ different beams and different internal louvers
- Philips flux optimization tool
- Surge protection up to 10 kV
- Wide range of lumen packages, ranging from 1,000 to 89,000 lm
- Various CCTs ranging from 1800K – 5700K

Application

- Motorways, inter-urban main roads, boulevards and avenues, roundabouts, pedestrian crossings
- Residential streets, side streets, squares, parks, cycle and pedestrian paths, playgrounds
- Parking areas, industrial areas, petrol stations, rail yards, airports, harbors, waterways

Versions



Luma gen2 Mini with SR connector



BGP701 Luma gen2 Nano
Wattstopper SPP

Luma gen2

Versions



BGP705 Luma gen2 Large top



BGP701 Luma gen2 Nano basis



Luma gen2 Medium bottom view



Luma gen2 Medium with
Wattstopper motion sensor



BGP704 Luma gen2 Medium SR
bottom 2 DGR



Luma gen2 Micro bottom view

Dimensional drawing

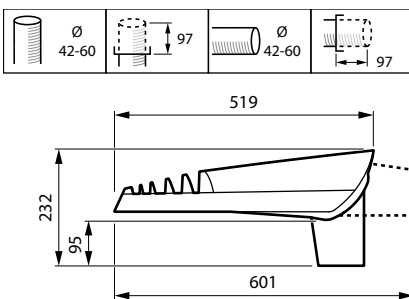
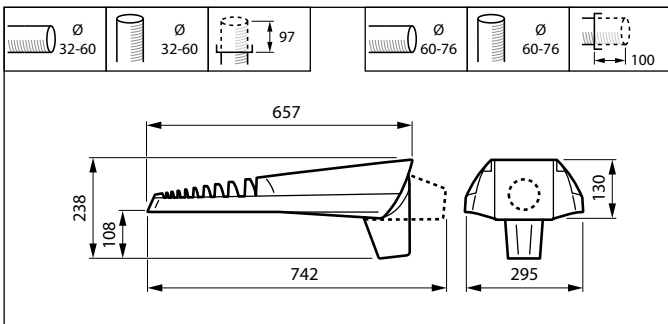
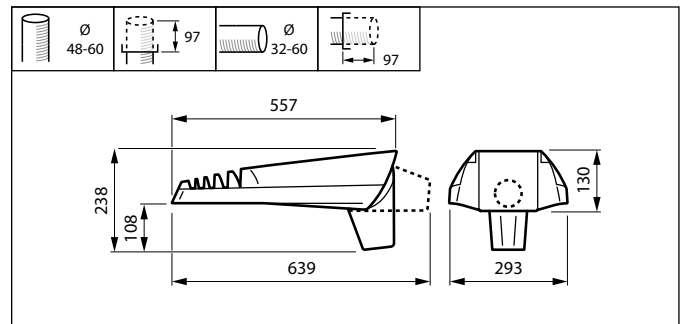
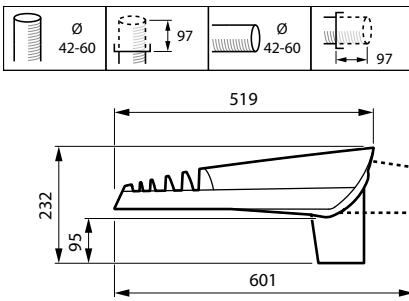
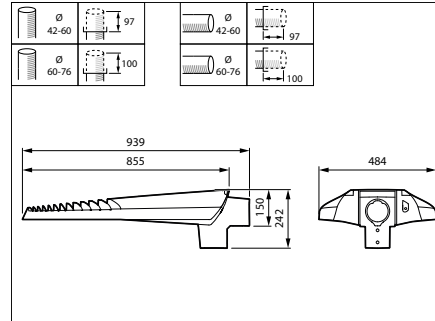
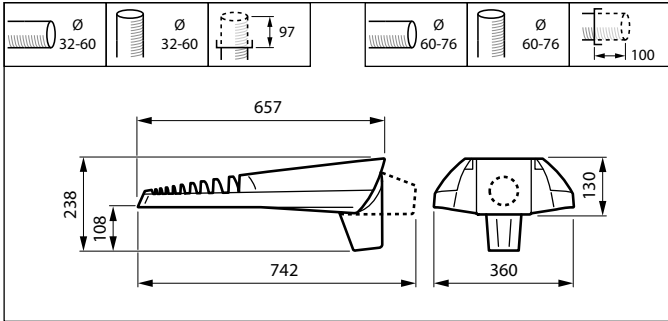

Luma gen2

Product details

BGP701 Luma gen2 Nano FG DPP



BGP701 Luma gen2 Nano Open2 DPP



BGP713 Luma gen2 Mini Compact Open1 DPP



BGP713 Luma gen2 Mini Compact Open2 DPP



BGP705 Luma gen2 Large FG DPP



BGP705 Luma gen2 Large Open1 DPP



General Information

Driver included	Yes
-----------------	-----

Light Technical

Upward light output ratio	0
---------------------------	---

Mechanical and Housing

Optical cover type	Glass
--------------------	-------

Ingress protection code	IP66
-------------------------	------

Approval and Application

CE mark	Yes
---------	-----

General Information

Order Code	Full Product Name	Lamp family code	Light source replaceable	Number of gear units	Service tag
910925870008	BGP703 LED120-1P/740 UE I DM11P SRTB GR	LED120	-	1 unit	-
910925867324	BGP701 LED8-4S/740 DM11 FG GR 42/60P	LED8	Yes	1 unit	Yes
910925867325	BGP701 LED40-4S/740 DM10 GF SRT SRB 42/6	LED40	Yes	1 unit	Yes
910925867326	BGP701 LW10 LED50-4S/830 DM11 GF CTGO-DG	LED50	Yes	1 unit	Yes
910925868804	BGP705 LED580-4S/730 DM11 DDF27 D18 SRG1	-	Yes	3 units	Yes
910925867788	BGP703 LED60-4S/740 II DM31 MSP CLO SRT	LED60	Yes	1 unit	Yes
910925867834	BGP703 LED100-4S/830 DM11 DDF27 D18 SRG1	LED100	Yes	1 unit	Yes
910925868136	BGP701 LED60-4S/740 II DM11 CLO SRT SRB	LED60	Yes	1 unit	Yes
910925868137	BGP701 LED60-4S/740 II DM11 CLO SRT SRB	LED60	Yes	1 unit	Yes
910925866534	BGP702 LED60-4S/740 DM11 GF SRT SRB 60/7	LED60	Yes	1 unit	Yes
910925866535	BGP702 LED40-4S/740 DM10 GF SRT SRB 60/7	LED40	Yes	1 unit	Yes
910925866536	BGP702 LW10 LED50-4S/830 DM11 GF CTGO	LED50	Yes	1 unit	Yes
910925867784	BGP702 LED40-4S/740 II DM10 MSP CLO SRT	LED40	Yes	1 unit	Yes
910925867785	BGP702 LED60-4S/740 II DM32 MSP CLO SRT	LED60	Yes	1 unit	Yes
910925867786	BGP702 LED60-4S/740 II DM11 CLO SRT SRB	LED60	Yes	1 unit	Yes

Order Code	Full Product Name	Lamp family code	Light source replaceable	Number of gear units	Service tag
910925867787	BGP702 LED60-4S/740 II DM11 CLO SRT SRB	LED60	Yes	1 unit	Yes
910925868042	BGP702 LED60-4S/740 DM11 PGR SRT SRB 60	LED60	Yes	1 unit	Yes
910925868043	BGP702 LED40-4S/740 DM10 PGR SRT SRB 60	LED40	Yes	1 unit	Yes
910925868044	BGP702 LW10 LED50-4S/830 DM11 PGR CTGO	LED50	Yes	1 unit	Yes
910925868801	BGP702 LED60-4S/730 DM11 DDF27 D18 SRG10	LED60	Yes	1 unit	Yes
910925870005	BGP702 LED60-1P/740 UE I DM11P SRTB GR 4	LED60	-	1 unit	-
910925868225	BGP701 LED60-4S/740 II DM32 MSP CLO SRT	LED60	Yes	1 unit	Yes
910925868227	BGP701 LED40-4S/740 II DM10 MSP CLO SRT	LED40	Yes	1 unit	Yes
910925868799	BGP701 LED60-4S/730 DM11 DDF27 D18 SRG10	LED60	Yes	1 unit	Yes
910925870002	BGP701 LED60-1P/740 UE DM11P SRTB GR 42/	LED60	-	1 unit	-
910925866542	BGP704 LED140-4S/740 DM50 GF SRT SRB 60	LED140	Yes	1 unit	Yes
910925866543	BGP704 LED210-4S/830 II DX10 GF D18 DDF3	LED210	Yes	1 unit	Yes
910925866544	BGP704 LW10 LED120-4S/830 DM11 GF CTGO	LED120	Yes	1 unit	Yes
910925867794	BGP704 LED260-4S/740 DM11 CLO SRT SRB 48	LED260	Yes	1 unit	Yes
910925867795	BGP704 LED260-4S/740 DM11 CLO SRT SRB 48	LED260	Yes	1 unit	Yes

Order Code	Full Product Name	Lamp family code	Light source replaceable	Number	Service tag
				of gear units	
910925868050	BGP704 LED140-4S/740 DM50 PGR SRT SRB 60	LED140	Yes	1 unit	Yes
910925868051	BGP704 LED210-4S/830 II DX10 PGR DDF3 D1	LED210	Yes	1 unit	Yes
910925868052	BGP704 LW10 LED120-4S/830 DM11 CTGO-DG	LED120	Yes	1 unit	Yes
910925868792	BGP704 LED100-4S/740 II DM32 MSP CLO- DDF	LED100	Yes	1 unit	Yes
910925868803	BGP704 LED230-4S/730 DM11 DDF27 D18 SRG1	LED230	Yes	1 unit	Yes
910925867142	BGP705 LED150-4S/740 DM11 GF SRT SRB 60/	LED150	Yes	1 unit	Yes
910925867143	BGP705 LED300-4S/740 II DM11 GF SRT SRB	LED300	Yes	3 units	Yes
910925868406	BGP713 LED120-4S/740 DM50 GF SRT SRB 60	LED120-4S	Yes	1 unit	Yes
910925868407	BGP713 LED100-4S/830 II DW50 GF SRT SRB	LED100-4S	Yes	1 unit	Yes
910925868409	BGP713 LED50-4S/740 II DM11 GF EZR SRB 6	LED50-4S	Yes	1 unit	Yes
910925870011	BGP713 LED120-1P/740 UE I DM11P PSU 42/6	LED120-4S	-	1 unit	-
910925867835	BGP704 LED210-4S/830	LED210	Yes	1 unit	Yes

Order Code	Full Product Name	Lamp family code	Light source replaceable	Number	Service tag
				of gear units	
	DM11 DDF27 D18 SRG1				
910925868226	BGP705 LED300-4S/740 II DM32 MSP CLO SRT	LED300	Yes	3 units	Yes
910925870017	BGP705 LED500-1P/740 UE I DM11P SRTB GR	LED500	-	1 unit	-
910925870014	BGP704 LED140-1P/740 UEI DM11P SRTB GR	LED140	-	1 unit	-
910925866538	BGP703 LED120-4S/740 DM50 GF SRT SRB 60	LED120	Yes	1 unit	Yes
910925866539	BGP703 LED100-4S/830 II DW50 GF SRT SRB	LED100	Yes	1 unit	Yes
910925867789	BGP703 LED120-4S/740 II DM11 CLO SRT SRB	LED120	Yes	1 unit	Yes
910925867790	BGP703 LED120-4S/740 II DM11 CLO SRT SRB	LED120	Yes	1 unit	Yes
910925867791	BGP703 LED120-4S/740 II DM32 MSP CLO SRT	LED120	Yes	1 unit	Yes
910925868046	BGP703 LED120-4S/740 DM50 PGR SRT SRB 60	LED120	Yes	1 unit	Yes
910925868047	BGP703 LED100-4S/830 II DW50 PGR SRT SRB	LED100	Yes	1 unit	Yes
910925868802	BGP703 LED120-4S/730 DM11 DDF27 D18 SRG1	LED120	Yes	1 unit	Yes
910925867833	BGP702 LED50-4S/830 DM11 DDF27 D18 SRG10	LED50	Yes	1 unit	Yes

Light Technical

Order Code	Full Product Name	Luminaire light beam spread	Light source color	Correlated Color	Color rendering	Luminous Flux	Optic type outdoor
				Temperature (Nom)	index (CRI)		
910925870008	BGP703 LED120-1P/740 UE I DM11P SRTB GR	60° - 21° x 153°	740 neutral white	4000 K	70	11,040 lm	Distribution medium 11

Order Code	Full Product Name	Luminaire light beam		Correlated Color		Color rendering		Optic type outdoor
		spread	Light source color	Temperature (Nom)	index (CRI)	Luminous Flux		
910925867324	BGP701 LED8-4S/740 DM11 FG GR 42/60P	70° x 37°	740 neutral white	4000 K	70	728 lm	Distribution medium 11	
910925867325	BGP701 LED40-4S/740 DM10 GF SRT SRB 42/6	73° x 44°	740 neutral white	4000 K	70	3,600 lm	Distribution medium 10	
910925867326	BGP701 LW10 LED50-4S/830 DM11 GF CTGO-DG	70° x 37°	830 warm white	3000 K	80	4,500 lm	Distribution medium 11	
910925868804	BGP705 LED580-4S/730 DM11 DDF27 D18 SRG1	70° x 37°	730 warm white	3000 K	70	48,140 lm	Distribution medium 11	
910925867788	BGP703 LED60-4S/740 II DM31 MSP CLO SRT	65° x 23°	740 neutral white	4000 K	70	5,278 lm	Distribution medium 31	
910925867834	BGP703 LED100-4S/830 DM11 DDF27 D18 SRG1	70° x 37°	830 warm white	3000 K	80	9,100 lm	Distribution medium 32	
910925868136	BGP701 LED60-4S/740 II DM11 CLO SRT SRB	70° x 37°	740 neutral white	4000 K	70	5,220 lm	Distribution medium 11	
910925868137	BGP701 LED60-4S/740 II DM11 CLO SRT SRB	70° x 37°	740 neutral white	4000 K	70	5,220 lm	Distribution medium 11	
910925866534	BGP702 LED60-4S/740 DM11 GF SRT SRB 60/7	70° x 37°	740 neutral white	4000 K	70	5,400 lm	Distribution medium 11	
910925866535	BGP702 LED40-4S/740 DM10 GF SRT SRB 60/7	73° x 44°	740 neutral white	4000 K	70	3,600 lm	Distribution medium 10	
910925866536	BGP702 LW10 LED50-4S/830 DM11 GF CTGO	70° x 37°	830 warm white	3000 K	80	4,500 lm	Distribution medium 11	
910925867784	BGP702 LED40-4S/740 II DM10 MSP CLO SRT	73° x 44°	740 neutral white	4000 K	70	3,510 lm	Distribution medium 10	
910925867785	BGP702 LED60-4S/740 II DM32 MSP CLO SRT	65° x 39°	740 neutral white	4000 K	70	5,278 lm	Distribution medium 32	
910925867786	BGP702 LED60-4S/740 II DM11 CLO SRT SRB	70° x 37°	740 neutral white	4000 K	70	5,220 lm	Distribution medium 11	
910925867787	BGP702 LED60-4S/740 II DM11 CLO SRT SRB	70° x 37°	740 neutral white	4000 K	70	5,220 lm	Distribution medium 11	
910925868042	BGP702 LED60-4S/740 DM11 PGR SRT SRB 60	70° x 37°	740 neutral white	4000 K	70	5,400 lm	Distribution medium 11	
910925868043	BGP702 LED40-4S/740 DM10 PGR SRT SRB 60	73° x 44°	740 neutral white	4000 K	70	3,600 lm	Distribution medium 10	
910925868044	BGP702 LW10 LED50-4S/830 DM11 PGR CTGO	70° x 37°	830 warm white	3000 K	80	4,500 lm	Distribution medium 11	
910925868801	BGP702 LED60-4S/730 DM11 DDF27 D18 SRG10	70° x 37°	730 warm white	3000 K	70	5,400 lm	Distribution medium 11	
910925870005	BGP702 LED60-1P/740 UE I DM11P SRTB GR 4	60° - 21° x 153°	740 neutral white	4000 K	70	5,520 lm	Distribution medium 11	
910925868225	BGP701 LED60-4S/740 II DM32 MSP CLO SRT	65° x 39°	740 neutral white	4000 K	70	3,510 lm	Distribution medium 32	
910925868227	BGP701 LED40-4S/740 II DM10 MSP CLO SRT	73° x 44°	740 neutral white	4000 K	70	3,510 lm	Distribution medium 10	
910925868799	BGP701 LED60-4S/730 DM11 DDF27 D18 SRG10	70° x 37°	730 warm white	3000 K	70	5,400 lm	Distribution medium 11	
910925870002	BGP701 LED60-1P/740 UE DM11P SRTB GR 42/	60° - 21° x 153°	740 neutral white	4000 K	70	5,520 lm	Distribution medium 11	
910925866542	BGP704 LED140-4S/740 DM50 GF SRT SRB 60	154° - 31° x 54°	740 neutral white	4000 K	70	12,740 lm	Distribution medium 50	

Order Code	Full Product Name	Luminaire light beam		Correlated Color		Color rendering		Optic type outdoor
		spread	Light source color	Temperature (Nom)	index (CRI)	Luminous Flux		
910925866543	BGP704 LED210-4S/830 II DX10 GF D18 DDF3	150° - 43° x 67°	830 warm white	3000 K	80	17,850 lm	Distribution extra wide 10	
910925866544	BGP704 LW10 LED120-4S/830 DM11 GF CTGO	70° x 37°	830 warm white	3000 K	80	10,920 lm	Distribution medium 11	
910925867794	BGP704 LED260-4S/740 DM11 CLO SRT SRB 48	70° x 37°	740 neutral white	4000 K	70	22,500 lm	Distribution medium 31	
910925867795	BGP704 LED260-4S/740 DM11 CLO SRT SRB 48	70° x 37°	740 neutral white	4000 K	70	22,500 lm	Distribution medium 11	
910925868050	BGP704 LED140-4S/740 DM50 PGR SRT SRB 60	154° - 31° x 54°	740 neutral white	4000 K	70	12,740 lm	Distribution medium 50	
910925868051	BGP704 LED210-4S/830 II DX10 PGR DDF3 D1	150° - 43° x 67°	830 warm white	3000 K	80	17,850 lm	Distribution extra wide 10	
910925868052	BGP704 LW10 LED120-4S/830 DM11 CTGO-DG	70° x 37°	830 warm white	3000 K	80	10,920 lm	Distribution medium 11	
910925868792	BGP704 LED100-4S/740 II DM32 MSP CLO-DDF	65° x 39°	740 neutral white	4000 K	70	9,016 lm	Distribution medium 32	
910925868803	BGP704 LED230-4S/730 DM11 DDF27 D18 SRG1	70° x 37°	730 warm white	3000 K	70	20,700 lm	Distribution medium 11	
910925867142	BGP705 LED150-4S/740 DM11 GF SRT SRB 60/	70° x 37°	740 neutral white	4000 K	70	13,500 lm	Distribution medium 11	
910925867143	BGP705 LED300-4S/740 II DM11 GF SRT SRB	70° x 37°	740 neutral white	4000 K	70	26,700 lm	Distribution medium 11	
910925868406	BGP713 LED120-4S/740 DM50 GF SRT SRB 60	42° x 85°	740 neutral white	4000 K	70	10,800 lm	Distribution medium 50	
910925868407	BGP713 LED100-4S/830 II DW50 GF SRT SRB	40° x 42°	830 warm white	3000 K	80	8,600 lm	Distribution wide 50	
910925868409	BGP713 LED50-4S/740 II DM11 GF EZR SRB 6	160° x 95°	740 neutral white	4000 K	70	4,550 lm	Distribution medium 11	
910925870011	BGP713 LED120-1P/740 UE I DM11P PSU 42/6	60° - 21° x 153°	740 neutral white	4000 K	70	11,040 lm	Distribution medium 11	
910925867835	BGP704 LED210-4S/830 DM11 DDF27 D18 SRG1	70° x 37°	830 warm white	3000 K	80	18,900 lm	Distribution medium 31	
910925868226	BGP705 LED300-4S/740 II DM32 MSP CLO SRT	65° x 39°	740 neutral white	4000 K	70	26,100 lm	Distribution medium 32	
910925870017	BGP705 LED500-1P/740 UE I DM11P SRTB GR	60° - 21° x 153°	740 neutral white	4000 K	70	46,000 lm	Distribution medium 11	
910925870014	BGP704 LED140-1P/740 UEI DM11P SRTB GR	60° - 21° x 153°	740 neutral white	4000 K	70	12,740 lm	Distribution medium 11	
910925866538	BGP703 LED120-4S/740 DM50 GF SRT SRB 60	154° - 31° x 54°	740 neutral white	4000 K	70	10,800 lm	Distribution medium 50	
910925866539	BGP703 LED100-4S/830 II DW50 GF SRT SRB	150° - 43° x 67°	830 warm white	3000 K	80	8,600 lm	Distribution wide 50	
910925867789	BGP703 LED120-4S/740 II DM11 CLO SRT SRB	70° x 37°	740 neutral white	4000 K	70	10,350 lm	Distribution medium 11	
910925867790	BGP703 LED120-4S/740 II DM11 CLO SRT SRB	70° x 37°	740 neutral white	4000 K	70	10,350 lm	Distribution medium 11	
910925867791	BGP703 LED120-4S/740 II DM32 MSP CLO SRT	65° x 39°	740 neutral white	4000 K	70	10,465 lm	Distribution medium 32	
910925868046	BGP703 LED120-4S/740 DM50 PGR SRT SRB 60	154° - 31° x 54°	740 neutral white	4000 K	70	10,800 lm	Distribution medium 50	

Order Code	Full Product Name	Luminaire light beam		Correlated Color		Color rendering		Luminous Flux	Optic type outdoor
		spread	Light source color	Temperature (Nom)	index (CRI)				
910925868047	BGP703 LED100-4S/830 II DW50 PGR SRT SRB	150° - 43° x 67°	830 warm white	3000 K	80	8,600 lm	Distribution wide 50		
910925868802	BGP703 LED120-4S/730 DM11 DDF27 D18 SRG1	70° x 37°	730 warm white	3000 K	70	10,800 lm	Distribution medium 11		
910925867833	BGP702 LED50-4S/830 DM11 DDF27 D18 SRG10	70° x 37°	830 warm white	3000 K	80	4,500 lm	Distribution medium 11		

Operating and Electrical

Order Code	Full Product Name	Power Consumption	Surge Protection (Common/Differential)	Order Code	Full Product Name	Power Consumption	Surge Protection (Common/Differential)
910925870008	BGP703 LED120-1P/740 UE I DM11P SRTB GR	61 W	Luminaire surge protection level until 6 kV differential mode and 8 kV common mode	910925866535	BGP702 LED40-4S/740 DM10 GF SRT SRB 60/7	25 W	Luminaire surge protection level until 6 kV differential mode and 8 kV common mode
910925867324	BGP701 LED8-4S/740 DM11 FG GR 42/60P	6.1 W	Luminaire surge protection level until 6 kV differential mode and 8 kV common mode	910925866536	BGP702 LW10 LED50-4S/830 DM11 GF CTGO	40.5 W	Luminaire surge protection level until 6 kV differential mode and 8 kV common mode
910925867325	BGP701 LED40-4S/740 DM10 GF SRT SRB 42/6	25 W	Luminaire surge protection level until 6 kV differential mode and 8 kV common mode	910925867784	BGP702 LED40-4S/740 II DM10 MSP CLO SRT	24 W	Surge protection level until 10 kV differential mode
910925867326	BGP701 LW10 LED50-4S/830 DM11 GF CTGO-DG	40.5 W	Luminaire surge protection level until 6 kV differential mode and 8 kV common mode	910925867785	BGP702 LED60-4S/740 II DM32 MSP CLO SRT	37 W	Surge protection level until 10 kV differential mode
910925868804	BGP705 LED580-4S/730 DM11 DDF27 D18 SRG1	375 W	Luminaire surge protection level until 10 kV differential mode and 10 kV common mode	910925867786	BGP702 LED60-4S/740 II DM11 CLO SRT SRB	37 W	Luminaire surge protection level until 6 kV differential mode and 8 kV common mode
910925867788	BGP703 LED60-4S/740 II DM31 MSP CLO SRT	37 W	Surge protection level until 10 kV differential mode	910925867787	BGP702 LED60-4S/740 II DM11 CLO SRT SRB	37 W	Luminaire surge protection level until 6 kV differential mode and 8 kV common mode
910925867834	BGP703 LED100-4S/830 DM11 DDF27 D18 SRG1	79 W	Luminaire surge protection level until 10 kV differential mode and 10 kV common mode	910925868042	BGP702 LED60-4S/740 DM11 PGR SRT SRB 60	38 W	Luminaire surge protection level until 6 kV differential mode and 8 kV common mode
910925868136	BGP701 LED60-4S/740 II DM11 CLO SRT SRB	37 W	Luminaire surge protection level until 6 kV differential mode and 8 kV common mode	910925868043	BGP702 LED40-4S/740 DM10 PGR SRT SRB 60	25 W	Luminaire surge protection level until 6 kV differential mode and 8 kV common mode
910925868137	BGP701 LED60-4S/740 II DM11 CLO SRT SRB	37 W	Luminaire surge protection level until 6 kV differential mode and 8 kV common mode	910925868044	BGP702 LW10 LED50-4S/830 DM11 PGR CTGO	40.5 W	Luminaire surge protection level until 6 kV differential mode and 8 kV common mode
910925866534	BGP702 LED60-4S/740 DM11 GF SRT SRB 60/7	38 W	Luminaire surge protection level until 6 kV differential mode and 8 kV common mode	910925868801	BGP702 LED60-4S/730 DM11 DDF27 D18 SRG10	40.5 W	Luminaire surge protection level until 10 kV differential mode and 10 kV common mode

Order Code	Full Product Name	Power Consumption	Surge Protection (Common/Differential)
910925870005	BGP702 LED60-1P/740 UE I DM11P SRTB GR 4	31 W	Luminaire surge protection level until 6 kV differential mode and 8 kV common mode
910925868225	BGP701 LED60-4S/740 II DM32 MSP CLO SRT	38 W	Surge protection level until 10 kV differential mode
910925868227	BGP701 LED40-4S/740 II DM10 MSP CLO SRT	24 W	Surge protection level until 10 kV differential mode
910925868799	BGP701 LED60-4S/730 DM11 DDF27 D18 SRG10	42 W	Luminaire surge protection level until 10 kV differential mode and 10 kV common mode
910925870002	BGP701 LED60-1P/740 UE DM11P SRTB GR 42/	31 W	Luminaire surge protection level until 6 kV differential mode and 8 kV common mode
910925866542	BGP704 LED140-4S/740 DM50 GF SRT SRB 60	83 W	Luminaire surge protection level until 6 kV differential mode and 8 kV common mode
910925866543	BGP704 LED210-4S/830 II DX10 GF D18 DDF3	166 W	Luminaire surge protection level until 6 kV differential mode and 8 kV common mode
910925866544	BGP704 LW10 LED120-4S/830 DM11 GF CTGO	91 W	Luminaire surge protection level until 6 kV differential mode and 8 kV common mode
910925867794	BGP704 LED260-4S/740 DM11 CLO SRT SRB 48	154 W	Luminaire surge protection level until 6 kV differential mode and 8 kV common mode
910925867795	BGP704 LED260-4S/740 DM11 CLO SRT SRB 48	154 W	Luminaire surge protection level until 6 kV differential mode and 8 kV common mode
910925868050	BGP704 LED140-4S/740 DM50 PGR SRT SRB 60	83 W	Luminaire surge protection level until 6 kV differential mode and 8 kV common mode
910925868051	BGP704 LED210-4S/830 II DX10 PGR DDF3 D1	166 W	Luminaire surge protection level until 6 kV differential mode and 8 kV common mode
910925868052	BGP704 LW10 LED120-4S/830 DM11 CTGO-DG	91 W	Luminaire surge protection level until 6 kV differential mode and 8 kV common mode

Order Code	Full Product Name	Power Consumption	Surge Protection (Common/Differential)
910925868792	BGP704 LED100-4S/740 II DM32 MSP CLO-DDF	57 W	Luminaire surge protection level until 6 kV differential mode and 8 kV common mode
910925868803	BGP704 LED230-4S/730 DM11 DDF27 D18 SRG1	150 W	Luminaire surge protection level until 10 kV differential mode and 10 kV common mode
910925867142	BGP705 LED150-4S/740 DM11 GF SRT SRB 60/	87 W	Luminaire surge protection level until 6 kV differential mode and 8 kV common mode
910925867143	BGP705 LED300-4S/740 II DM11 GF SRT SRB	174 W	Luminaire surge protection level until 6 kV differential mode and 8 kV common mode
910925868406	BGP713 LED120-4S/740 DM50 GF SRT SRB 60	74 W	Luminaire surge protection level until 6 kV differential mode and 8 kV common mode
910925868407	BGP713 LED100-4S/830 II DW50 GF SRT SRB	79 W	Luminaire surge protection level until 6 kV differential mode and 8 kV common mode
910925868409	BGP713 LED50-4S/740 II DM11 GF EZR SRB 6	31.5 W	Luminaire surge protection level until 6 kV differential mode and 8 kV common mode
910925870011	BGP713 LED120-1P/740 UE I DM11P PSU 42/6	61 W	Luminaire surge protection level until 10 kV differential mode and 10 kV common mode
910925867835	BGP704 LED210-4S/830 DM11 DDF27 D18 SRG1	166 W	Luminaire surge protection level until 10 kV differential mode and 10 kV common mode
910925868226	BGP705 LED300-4S/740 II DM32 MSP CLO SRT	170 W	Surge protection level until 10 kV differential mode
910925870017	BGP705 LED500-1P/740 UE I DM11P SRTB GR	250 W	Luminaire surge protection level until 6 kV differential mode and 8 kV common mode
910925870014	BGP704 LED140-1P/740 UEI DM11P SRTB GR	68 W	Luminaire surge protection level until 6 kV differential mode and 8 kV common mode
910925866538	BGP703 LED120-4S/740 DM50 GF SRT SRB 60	74 W	Luminaire surge protection level until 6 kV differential mode and 8 kV common mode

Luma gen2

Order Code	Full Product Name	Power Consumption	Surge Protection (Common/Differential)
910925866539	BGP703 LED100-4S/830 II DW50 GF SRT SRB	79 W	Luminaire surge protection level until 6 kV differential mode and 8 kV common mode
910925867789	BGP703 LED120-4S/740 II DM11 CLO SRT SRB	71 W	Luminaire surge protection level until 6 kV differential mode and 8 kV common mode
910925867790	BGP703 LED120-4S/740 II DM11 CLO SRT SRB	71 W	Luminaire surge protection level until 6 kV differential mode and 8 kV common mode
910925867791	BGP703 LED120-4S/740 II DM32 MSP CLO SRT	71 W	Surge protection level until 10 kV differential mode
910925868046	BGP703 LED120-4S/740 DM50 PGR SRT SRB 60	74 W	Luminaire surge protection level until 6 kV differential mode and 8 kV common mode

Order Code	Full Product Name	Power Consumption	Surge Protection (Common/Differential)
910925868047	BGP703 LED100-4S/830 II DW50 PGR SRT SRB	79 W	Luminaire surge protection level until 6 kV differential mode and 8 kV common mode
910925868802	BGP703 LED120-4S/730 DM11 DDF27 D18 SRG1	79 W	Luminaire surge protection level until 10 kV differential mode and 10 kV common mode
910925867833	BGP702 LED50-4S/830 DM11 DDF27 D18 SRG10	40.5 W	Luminaire surge protection level until 10 kV differential mode and 10 kV common mode

Controls and Dimming

Order Code	Full Product Name	Dimmable	Maximum dim level
910925870008	BGP703 LED120-1P/740 UE I DM11P SRTB GR	No	Not applicable
910925867324	BGP701 LED8-4S/740 DM11 FG GR 42/60P	No	Not applicable
910925867325	BGP701 LED40-4S/740 DM10 GF SRT SRB 42/6	No	Not applicable
910925867326	BGP701 LW10 LED50-4S/830 DM11 GF CTGO-DG	Yes	Not applicable
910925868804	BGP705 LED580-4S/730 DM11 DDF27 D18 SRG1	Yes	50%
910925867788	BGP703 LED60-4S/740 II DM31 MSP CLO SRT	No	Not applicable
910925867834	BGP703 LED100-4S/830 DM11 DDF27 D18 SRG1	Yes	50%
910925868136	BGP701 LED60-4S/740 II DM11 CLO SRT SRB	No	Not applicable
910925868137	BGP701 LED60-4S/740 II DM11 CLO SRT SRB	No	Not applicable
910925866534	BGP702 LED60-4S/740 DM11 GF SRT SRB 60/7	No	Not applicable
910925866535	BGP702 LED40-4S/740 DM10 GF SRT SRB 60/7	No	Not applicable
910925866536	BGP702 LW10 LED50-4S/830 DM11 GF CTGO	Yes	Not applicable
910925867784	BGP702 LED40-4S/740 II DM10 MSP CLO SRT	No	Not applicable

Order Code	Full Product Name	Dimmable	Maximum dim level
910925867785	BGP702 LED60-4S/740 II DM32 MSP CLO SRT	No	Not applicable
910925867786	BGP702 LED60-4S/740 II DM11 CLO SRT SRB	No	Not applicable
910925867787	BGP702 LED60-4S/740 II DM11 CLO SRT SRB	No	Not applicable
910925868042	BGP702 LED60-4S/740 DM11 PGR SRT SRB 60	No	Not applicable
910925868043	BGP702 LED40-4S/740 DM10 PGR SRT SRB 60	No	Not applicable
910925868044	BGP702 LW10 LED50-4S/830 DM11 PGR CTGO	Yes	Not applicable
910925868801	BGP702 LED60-4S/730 DM11 DDF27 D18 SRG10	Yes	50%
910925870005	BGP702 LED60-1P/740 UE I DM11P SRTB GR 4	No	Not applicable
910925868225	BGP701 LED60-4S/740 II DM32 MSP CLO SRT	No	Not applicable
910925868227	BGP701 LED40-4S/740 II DM10 MSP CLO SRT	No	Not applicable
910925868799	BGP701 LED60-4S/730 DM11 DDF27 D18 SRG10	Yes	50%
910925870002	BGP701 LED60-1P/740 UE DM11P SRTB GR 42/	No	Not applicable
910925866542	BGP704 LED140-4S/740 DM50 GF SRT SRB 60	No	Not applicable

Order Code	Full Product Name	Dimmable	Maximum dim level
910925866543	BGP704 LED210-4S/830 II DX10 GF D18 DDF3	Yes	30%
910925866544	BGP704 LW10 LED120-4S/830 DM11 GF CTGO	Yes	Not applicable
910925867794	BGP704 LED260-4S/740 DM11 CLO SRT SRB 48	No	Not applicable
910925867795	BGP704 LED260-4S/740 DM11 CLO SRT SRB 48	No	50%
910925868050	BGP704 LED140-4S/740 DM50 PGR SRT SRB 60	No	Not applicable
910925868051	BGP704 LED210-4S/830 II DX10 PGR DDF3 D1	Yes	30%
910925868052	BGP704 LW10 LED120-4S/830 DM11 CTGO-DG	Yes	Not applicable
910925868792	BGP704 LED100-4S/740 II DM32 MSP CLO-DDF	Yes	50%
910925868803	BGP704 LED230-4S/730 DM11 DDF27 D18 SRG1	Yes	50%
910925867142	BGP705 LED150-4S/740 DM11 GF SRT SRB 60/	No	Not applicable
910925867143	BGP705 LED300-4S/740 II DM11 GF SRT SRB	No	Not applicable
910925868406	BGP713 LED120-4S/740 DM50 GF SRT SRB 60	No	Not applicable
910925868407	BGP713 LED100-4S/830 II DW50 GF SRT SRB	No	Not applicable
910925868409	BGP713 LED50-4S/740 II DM11 GF EZR SRB 6	Yes	1%

Order Code	Full Product Name	Dimmable	Maximum dim level
910925870011	BGP713 LED120-1P/740 UE I DM11P PSU 42/6	No	Not applicable
910925867835	BGP704 LED210-4S/830 DM11 DDF27 D18 SRG1	Yes	50%
910925868226	BGP705 LED300-4S/740 II DM32 MSP CLO SRT	No	Not applicable
910925870017	BGP705 LED500-1P/740 UE I DM11P SRTB GR	No	Not applicable
910925870014	BGP704 LED140-1P/740 UEI DM11P SRTB GR	No	Not applicable
910925866538	BGP703 LED120-4S/740 DM50 GF SRT SRB 60	No	Not applicable
910925866539	BGP703 LED100-4S/830 II DW50 GF SRT SRB	No	Not applicable
910925867789	BGP703 LED120-4S/740 II DM11 CLO SRT SRB	No	Not applicable
910925867790	BGP703 LED120-4S/740 II DM11 CLO SRT SRB	No	Not applicable
910925867791	BGP703 LED120-4S/740 II DM32 MSP CLO SRT	No	Not applicable
910925868046	BGP703 LED120-4S/740 DM50 PGR SRT SRB 60	No	Not applicable
910925868047	BGP703 LED100-4S/830 II DW50 PGR SRT SRB	No	Not applicable
910925868802	BGP703 LED120-4S/730 DM11 DDF27 D18 SRG1	Yes	50%
910925867833	BGP702 LED50-4S/830 DM11 DDF27 D18 SRG10	Yes	50%

Mechanical and Housing

Order Code	Full Product Name	Housing Color	Mech. impact protection code	Standard tilt angle side entry	Standard tilt angle posttop
910925870008	BGP703 LED120-1P/740 UE I DM11P SRTB GR	Gray	IK09	0°	0°
910925867324	BGP701 LED8-4S/740 DM11 FG GR 42/60P	Gray	IK10	-	0°
910925867325	BGP701 LED40-4S/740 DM10 GF SRT SRB 42/6	Gray	IK09	-	0°
910925867326	BGP701 LW10 LED50-4S/830 DM11 GF CTGO-DG	Gray	IK09	-	0°
910925868804	BGP705 LED580-4S/730 DM11 DDF27 D18 SRG1	Grey	IK10	0°	-

Order Code	Full Product Name	Housing Color	Mech. impact protection code	Standard tilt angle side entry	Standard tilt angle posttop
910925867788	BGP703 LED60-4S/740 II DM31 MSP CLO SRT	Gray	IK09	-	0°
910925867834	BGP703 LED100-4S/830 DM11 DDF27 D18 SRG1	Gray	IK10	0°	-
910925868136	BGP701 LED60-4S/740 II DM11 CLO SRT SRB	Gray	IK09	0°	-
910925868137	BGP701 LED60-4S/740 II DM11 CLO SRT SRB	Gray	IK09	0°	-
910925866534	BGP702 LED60-4S/740 DM11 GF SRT SRB 60/7	Gray	IK09	-	0°

Order Code	Full Product Name	Housing Color	Mech. impact protection code	Standard tilt angle side entry	Standard tilt angle posttop
910925866535	BGP702 LED40-4S/740 DM10 GF SRT SRB 60/7	Gray	IK09	-	0°
910925866536	BGP702 LW10 LED50-4S/830 DM11 GF CTGO	Gray	IK09	-	0°
910925867784	BGP702 LED40-4S/740 II DM10 MSP CLO SRT	Gray	IK09	-	0°
910925867785	BGP702 LED60-4S/740 II DM32 MSP CLO SRT	Gray	IK09	-	0°
910925867786	BGP702 LED60-4S/740 II DM11 CLO SRT SRB	Gray	IK09	0°	-
910925867787	BGP702 LED60-4S/740 II DM11 CLO SRT SRB	Gray	IK09	0°	-
910925868042	BGP702 LED60-4S/740 DM11 PGR SRT SRB 60	Gray	IK09	-	0°
910925868043	BGP702 LED40-4S/740 DM10 PGR SRT SRB 60	Gray	IK09	-	0°
910925868044	BGP702 LW10 LED50-4S/830 DM11 PGR CTGO	Gray	IK09	-	0°
910925868801	BGP702 LED60-4S/730 DM11 DDF27 D18 SRG10	Gray	IK10	0°	-
910925870005	BGP702 LED60-1P/740 UE I DM11P SRTB GR 4	Gray	IK09	0°	0°
910925868225	BGP701 LED60-4S/740 II DM32 MSP CLO SRT	Gray	IK09	0°	0°
910925868227	BGP701 LED40-4S/740 II DM10 MSP CLO SRT	Gray	IK09	0°	0°
910925868799	BGP701 LED60-4S/730 DM11 DDF27 D18 SRG10	Gray	IK10	0°	-
910925870002	BGP701 LED60-1P/740 UE DM11P SRTB GR 42/	Gray	IK09	0°	0°
910925866542	BGP704 LED140-4S/740 DM50 GF SRT SRB 60	Gray	IK09	-	0°

Order Code	Full Product Name	Housing Color	Mech. impact protection code	Standard tilt angle side entry	Standard tilt angle posttop
910925866543	BGP704 LED210-4S/830 II DX10 GF D18 DDF3	Gray	IK10	-	0°
910925866544	BGP704 LW10 LED120-4S/830 DM11 GF CTGO	Gray	IK09	-	0°
910925867794	BGP704 LED260-4S/740 DM11 CLO SRT SRB 48	Gray	IK09	0°	-
910925867795	BGP704 LED260-4S/740 DM11 CLO SRT SRB 48	Gray	IK10	0°	-
910925868050	BGP704 LED140-4S/740 DM50 PGR SRT SRB 60	Gray	IK09	-	0°
910925868051	BGP704 LED210-4S/830 II DX10 PGR DDF3 D1	Gray	IK10	-	0°
910925868052	BGP704 LW10 LED120-4S/830 DM11 CTGO-DG	Gray	IK09	-	0°
910925868792	BGP704 LED100-4S/740 II DM32 MSP CLO-DDF	Gray	IK09	-	0°
910925868803	BGP704 LED230-4S/730 DM11 DDF27 D18 SRG1	Grey	IK10	0°	-
910925867142	BGP705 LED150-4S/740 DM11 GF SRT SRB 60/	Gray	IK09	-	0°
910925867143	BGP705 LED300-4S/740 II DM11 GF SRT SRB	Gray	IK09	-	0°
910925868406	BGP713 LED120-4S/740 DM50 GF SRT SRB 60	Gray	IK09	0°	0°
910925868407	BGP713 LED100-4S/830 II DW50 GF SRT SRB	Gray	IK09	0°	0°
910925868409	BGP713 LED50-4S/740 II DM11 GF EZR SRB 6	Dark gray	IK09	0°	0°
910925870011	BGP713 LED120-1P/740 UE I DM11P PSU 42/6	Gray	IK09	0°	0°
910925867835	BGP704 LED210-4S/830 DM11 DDF27 D18 SRG1	Gray	IK10	0°	-

Order Code	Full Product Name	Housing Color	Mech.	Standard tilt angle side entry	Standard tilt angle posttop
			impact protection code		
910925868226	BGP705 LED300-4S/740 II DM32 MSP CLO SRT	Gray	IK09	0°	0°
910925870017	BGP705 LED500-1P/740 UE I DM11P SRTB GR	Gray	IK09	0°	0°
910925870014	BGP704 LED140-1P/740 UEI DM11P SRTB GR	Gray	IK09	0°	0°
910925866538	BGP703 LED120-4S/740 DM50 GF SRT SRB 60	Gray	IK09	-	0°
910925866539	BGP703 LED100-4S/830 II DW50 GF SRT SRB	Gray	IK09	-	0°
910925867789	BGP703 LED120-4S/740 II DM11 CLO SRT SRB	Gray	IK09	-	0°

Order Code	Full Product Name	Housing Color	Mech.	Standard tilt angle side entry	Standard tilt angle posttop
			impact protection code		
910925867790	BGP703 LED120-4S/740 II DM11 CLO SRT SRB	Gray	IK09	0°	-
910925867791	BGP703 LED120-4S/740 II DM32 MSP CLO SRT	Gray	IK09	-	0°
910925868046	BGP703 LED120-4S/740 DM50 PGR SRT SRB 60	Gray	IK09	-	0°
910925868047	BGP703 LED100-4S/830 II DW50 PGR SRT SRB	Gray	IK09	-	0°
910925868802	BGP703 LED120-4S/730 DM11 DDF27 D18 SRG1	Gray	IK10	0°	-
910925867833	BGP702 LED50-4S/830 DM11 DDF27 D18 SRG10	Gray	IK10	0°	-

Approval and Application

Order Code	Full Product Name	Flammability mark
910925870008	BGP703 LED120-1P/740 UE I DM11P SRTB GR	-
910925867324	BGP701 LED8-4S/740 DM11 FG GR 42/60P	-
910925867325	BGP701 LED40-4S/740 DM10 GF SRT SRB 42/6	-
910925867326	BGP701 LW10 LED50-4S/830 DM11 GF CTGO-DG	-
910925868804	BGP705 LED580-4S/730 DM11 DDF27 D18 SRG1	-
910925867788	BGP703 LED60-4S/740 II DM31 MSP CLO SRT	-
910925867834	BGP703 LED100-4S/830 DM11 DDF27 D18 SRG1	-
910925868136	BGP701 LED60-4S/740 II DM11 CLO SRT SRB	-
910925868137	BGP701 LED60-4S/740 II DM11 CLO SRT SRB	-
910925866534	BGP702 LED60-4S/740 DM11 GF SRT SRB 60/7	-
910925866535	BGP702 LED40-4S/740 DM10 GF SRT SRB 60/7	-
910925866536	BGP702 LW10 LED50-4S/830 DM11 GF CTGO	-
910925867784	BGP702 LED40-4S/740 II DM10 MSP CLO SRT	-
910925867785	BGP702 LED60-4S/740 II DM32 MSP CLO SRT	-
910925867786	BGP702 LED60-4S/740 II DM11 CLO SRT SRB	-
910925867787	BGP702 LED60-4S/740 II DM11 CLO SRT SRB	-
910925868042	BGP702 LED60-4S/740 DM11 PGR SRT SRB 60	-
910925868043	BGP702 LED40-4S/740 DM10 PGR SRT SRB 60	-
910925868044	BGP702 LW10 LED50-4S/830 DM11 PGR CTGO	-
910925868801	BGP702 LED60-4S/730 DM11 DDF27 D18 SRG10	-
910925870005	BGP702 LED60-1P/740 UE I DM11P SRTB GR 4	-
910925868225	BGP701 LED60-4S/740 II DM32 MSP CLO SRT	-
910925868227	BGP701 LED40-4S/740 II DM10 MSP CLO SRT	-
910925868799	BGP701 LED60-4S/730 DM11 DDF27 D18 SRG10	-
910925870002	BGP701 LED60-1P/740 UE DM11P SRTB GR 42/	-
910925866542	BGP704 LED140-4S/740 DM50 GF SRT SRB 60	-
910925866543	BGP704 LED210-4S/830 II DX10 GF D18 DDF3	-

Order Code	Full Product Name	Flammability mark
910925866544	BGP704 LW10 LED120-4S/830 DM11 GF CTGO	-
910925867794	BGP704 LED260-4S/740 DM11 CLO SRT SRB 48	-
910925867795	BGP704 LED260-4S/740 DM11 CLO SRT SRB 48	-
910925868050	BGP704 LED140-4S/740 DM50 PGR SRT SRB 60	-
910925868051	BGP704 LED210-4S/830 II DX10 PGR DDF3 D1	-
910925868052	BGP704 LW10 LED120-4S/830 DM11 CTGO-DG	-
910925868792	BGP704 LED100-4S/740 II DM32 MSP CLO-DDF	-
910925868803	BGP704 LED230-4S/730 DM11 DDF27 D18 SRG1	-
910925867142	BGP705 LED150-4S/740 DM11 GF SRT SRB 60/	-
910925867143	BGP705 LED300-4S/740 II DM11 GF SRT SRB	-
910925868406	BGP713 LED120-4S/740 DM50 GF SRT SRB 60	For mounting on normally flammable surfaces
910925868407	BGP713 LED100-4S/830 II DW50 GF SRT SRB	For mounting on normally flammable surfaces
910925868409	BGP713 LED50-4S/740 II DM11 GF EZR SRB 6	For mounting on normally flammable surfaces
910925870011	BGP713 LED120-1P/740 UE I DM11P PSU 42/6	-
910925867835	BGP704 LED210-4S/830 DM11 DDF27 D18 SRG1	-
910925868226	BGP705 LED300-4S/740 II DM32 MSP CLO SRT	-
910925870017	BGP705 LED500-1P/740 UE I DM11P SRTB GR	-
910925870014	BGP704 LED140-1P/740 UEI DM11P SRTB GR	-
910925866538	BGP703 LED120-4S/740 DM50 GF SRT SRB 60	-
910925866539	BGP703 LED100-4S/830 II DW50 GF SRT SRB	-
910925867789	BGP703 LED120-4S/740 II DM11 CLO SRT SRB	-

Order Code	Full Product Name	Flammability mark
910925867790	BGP703 LED120-4S/740 II DM11 CLO SRT SRB	-
910925867791	BGP703 LED120-4S/740 II DM32 MSP CLO SRT	-
910925868046	BGP703 LED120-4S/740 DM50 PGR SRT SRB 60	-

Order Code	Full Product Name	Flammability mark
910925868047	BGP703 LED100-4S/830 II DW50 PGR SRT SRB	-
910925868802	BGP703 LED120-4S/730 DM11 DDF27 D18 SRG1	-
910925867833	BGP702 LED50-4S/830 DM11 DDF27 D18 SRG10	-

Over Time Performance (IEC Compliant)

Order Code	Full Product Name	Driver failure rate at 5000 h
910925870008	BGP703 LED120-1P/740 UE I DM11P SRTB GR	-
910925867324	BGP701 LED8-4S/740 DM11 FG GR 42/60P	-
910925867325	BGP701 LED40-4S/740 DM10 GF SRT SRB 42/6	-
910925867326	BGP701 LW10 LED50-4S/830 DM11 GF CTGO-DG	-
910925868804	BGP705 LED580-4S/730 DM11 DDF27 D18 SRG1	-
910925867788	BGP703 LED60-4S/740 II DM31 MSP CLO SRT	0.005 %
910925867834	BGP703 LED100-4S/830 DM11 DDF27 D18 SRG1	-
910925868136	BGP701 LED60-4S/740 II DM11 CLO SRT SRB	-
910925868137	BGP701 LED60-4S/740 II DM11 CLO SRT SRB	-
910925866534	BGP702 LED60-4S/740 DM11 GF SRT SRB 60/7	0.005 %
910925866535	BGP702 LED40-4S/740 DM10 GF SRT SRB 60/7	0.005 %
910925866536	BGP702 LW10 LED50-4S/830 DM11 GF CTGO	0.005 %
910925867784	BGP702 LED40-4S/740 II DM10 MSP CLO SRT	0.005 %
910925867785	BGP702 LED60-4S/740 II DM32 MSP CLO SRT	0.005 %
910925867786	BGP702 LED60-4S/740 II DM11 CLO SRT SRB	0.005 %
910925867787	BGP702 LED60-4S/740 II DM11 CLO SRT SRB	0.005 %
910925868042	BGP702 LED60-4S/740 DM11 PGR SRT SRB 60	-
910925868043	BGP702 LED40-4S/740 DM10 PGR SRT SRB 60	-
910925868044	BGP702 LW10 LED50-4S/830 DM11 PGR CTGO	-
910925868801	BGP702 LED60-4S/730 DM11 DDF27 D18 SRG10	-
910925870005	BGP702 LED60-1P/740 UE I DM11P SRTB GR 4	-
910925868225	BGP701 LED60-4S/740 II DM32 MSP CLO SRT	-
910925868227	BGP701 LED40-4S/740 II DM10 MSP CLO SRT	-
910925868799	BGP701 LED60-4S/730 DM11 DDF27 D18 SRG10	-
910925870002	BGP701 LED60-1P/740 UE DM11P SRTB GR 42/	-
910925866542	BGP704 LED140-4S/740 DM50 GF SRT SRB 60	0.005 %
910925866543	BGP704 LED210-4S/830 II DX10 GF D18 DDF3	0.005 %

Order Code	Full Product Name	Driver failure rate at 5000 h
910925866544	BGP704 LW10 LED120-4S/830 DM11 GF CTGO	0.005 %
910925867794	BGP704 LED260-4S/740 DM11 CLO SRT SRB 48	-
910925867795	BGP704 LED260-4S/740 DM11 CLO SRT SRB 48	-
910925868050	BGP704 LED140-4S/740 DM50 PGR SRT SRB 60	-
910925868051	BGP704 LED210-4S/830 II DX10 PGR DDF3 D1	-
910925868052	BGP704 LW10 LED120-4S/830 DM11 CTGO-DG	-
910925868792	BGP704 LED100-4S/740 II DM32 MSP CLO-DDF	-
910925868803	BGP704 LED230-4S/730 DM11 DDF27 D18 SRG1	-
910925867142	BGP705 LED150-4S/740 DM11 GF SRT SRB 60/	0.005 %
910925867143	BGP705 LED300-4S/740 II DM11 GF SRT SRB	0.005 %
910925868406	BGP713 LED120-4S/740 DM50 GF SRT SRB 60	-
910925868407	BGP713 LED100-4S/830 II DW50 GF SRT SRB	-
910925868409	BGP713 LED50-4S/740 II DM11 GF EZR SRB 6	-
910925870011	BGP713 LED120-1P/740 UE I DM11P PSU 42/6	-
910925867835	BGP704 LED210-4S/830 DM11 DDF27 D18 SRG1	-
910925868226	BGP705 LED300-4S/740 II DM32 MSP CLO SRT	-
910925870017	BGP705 LED500-1P/740 UE I DM11P SRTB GR	-
910925870014	BGP704 LED140-1P/740 UEI DM11P SRTB GR	-
910925866538	BGP703 LED120-4S/740 DM50 GF SRT SRB 60	0.005 %
910925866539	BGP703 LED100-4S/830 II DW50 GF SRT SRB	0.005 %
910925867789	BGP703 LED120-4S/740 II DM11 CLO SRT SRB	0.005 %
910925867790	BGP703 LED120-4S/740 II DM11 CLO SRT SRB	0.005 %
910925867791	BGP703 LED120-4S/740 II DM32 MSP CLO SRT	0.005 %
910925868046	BGP703 LED120-4S/740 DM50 PGR SRT SRB 60	-
910925868047	BGP703 LED100-4S/830 II DW50 PGR SRT SRB	-
910925868802	BGP703 LED120-4S/730 DM11 DDF27 D18 SRG1	-
910925867833	BGP702 LED50-4S/830 DM11 DDF27 D18 SRG10	-

Product Data

Order Code	Full Product Name	Product family code
910925870008	BGP703 LED120-1P/740 UE I DM11P SRTB GR	BGP703
910925867324	BGP701 LED8-4S/740 DM11 FG GR 42/60P	BGP701
910925867325	BGP701 LED40-4S/740 DM10 GF SRT SRB 42/6	BGP701
910925867326	BGP701 LW10 LED50-4S/830 DM11 GF CTGO-DG	BGP701
910925868804	BGP705 LED580-4S/730 DM11 DDF27 D18 SRG1	BGP705
910925867788	BGP703 LED60-4S/740 II DM31 MSP CLO SRT	BGP703
910925867834	BGP703 LED100-4S/830 DM11 DDF27 D18 SRG1	BGP703
910925868136	BGP701 LED60-4S/740 II DM11 CLO SRT SRB	BGP701
910925868137	BGP701 LED60-4S/740 II DM11 CLO SRT SRB	BGP701
910925866534	BGP702 LED60-4S/740 DM11 GF SRT SRB 60/7	BGP702
910925866535	BGP702 LED40-4S/740 DM10 GF SRT SRB 60/7	BGP702
910925866536	BGP702 LW10 LED50-4S/830 DM11 GF CTGO	BGP702

Order Code	Full Product Name	Product family code
910925867784	BGP702 LED40-4S/740 II DM10 MSP CLO SRT	BGP702
910925867785	BGP702 LED60-4S/740 II DM32 MSP CLO SRT	BGP702
910925867786	BGP702 LED60-4S/740 II DM11 CLO SRT SRB	BGP702
910925867787	BGP702 LED60-4S/740 II DM11 CLO SRT SRB	BGP702
910925868042	BGP702 LED60-4S/740 DM11 PGR SRT SRB 60	BGP702
910925868043	BGP702 LED40-4S/740 DM10 PGR SRT SRB 60	BGP702
910925868044	BGP702 LW10 LED50-4S/830 DM11 PGR CTGO	BGP702
910925868801	BGP702 LED60-4S/730 DM11 DDF27 D18 SRG10	BGP702
910925870005	BGP702 LED60-1P/740 UE I DM11P SRTB GR 4	BGP702
910925868225	BGP701 LED60-4S/740 II DM32 MSP CLO SRT	BGP701
910925868227	BGP701 LED40-4S/740 II DM10 MSP CLO SRT	BGP701
910925868799	BGP701 LED60-4S/730 DM11 DDF27 D18 SRG10	BGP701

Order Code	Full Product Name	Product family code
910925870002	BGP701 LED60-1P/740 UE DM11P SRTB GR 42/	BGP701
910925866542	BGP704 LED140-4S/740 DM50 GF SRT SRB 60	BGP704
910925866543	BGP704 LED210-4S/830 II DX10 GF D18 DDF3	BGP704
910925866544	BGP704 LW10 LED120-4S/830 DM11 GF CTGO	BGP704
910925867794	BGP704 LED260-4S/740 DM11 CLO SRT SRB 48	BGP704
910925867795	BGP704 LED260-4S/740 DM11 CLO SRT SRB 48	BGP704
910925868050	BGP704 LED140-4S/740 DM50 PGR SRT SRB 60	BGP704
910925868051	BGP704 LED210-4S/830 II DX10 PGR DDF3 D1	BGP704
910925868052	BGP704 LW10 LED120-4S/830 DM11 CTGO-DG	BGP704
910925868792	BGP704 LED100-4S/740 II DM32 MSP CLO-DDF	BGP704
910925868803	BGP704 LED230-4S/730 DM11 DDF27 D18 SRG1	BGP704
910925867142	BGP705 LED150-4S/740 DM11 GF SRT SRB 60/	BGP705
910925867143	BGP705 LED300-4S/740 II DM11 GF SRT SRB	BGP705
910925868406	BGP713 LED120-4S/740 DM50 GF SRT SRB 60	BGP713
910925868407	BGP713 LED100-4S/830 II DW50 GF SRT SRB	BGP713

Order Code	Full Product Name	Product family code
910925868409	BGP713 LED50-4S/740 II DM11 GF EZR SRB 6	BGP713
910925870011	BGP713 LED120-1P/740 UE I DM11P PSU 42/6	BGP713
910925867835	BGP704 LED210-4S/830 DM11 DDF27 D18 SRG1	BGP704
910925868226	BGP705 LED300-4S/740 II DM32 MSP CLO SRT	BGP705
910925870017	BGP705 LED500-1P/740 UE I DM11P SRTB GR	BGP705
910925870014	BGP704 LED140-1P/740 UEI DM11P SRTB GR	BGP704
910925866538	BGP703 LED120-4S/740 DM50 GF SRT SRB 60	BGP703
910925866539	BGP703 LED100-4S/830 II DW50 GF SRT SRB	BGP703
910925867789	BGP703 LED120-4S/740 II DM11 CLO SRT SRB	BGP703
910925867790	BGP703 LED120-4S/740 II DM11 CLO SRT SRB	BGP703
910925867791	BGP703 LED120-4S/740 II DM32 MSP CLO SRT	BGP703
910925868046	BGP703 LED120-4S/740 DM50 PGR SRT SRB 60	BGP703
910925868047	BGP703 LED100-4S/830 II DW50 PGR SRT SRB	BGP703
910925868802	BGP703 LED120-4S/730 DM11 DDF27 D18 SRG1	BGP703
910925867833	BGP702 LED50-4S/830 DM11 DDF27 D18 SRG10	BGP702

Polar Wide Diagrams

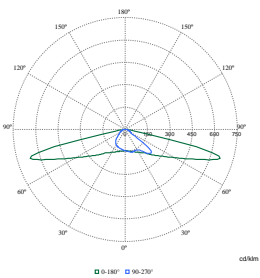

Polar Normal (separate) - BGP713I - 910925868406

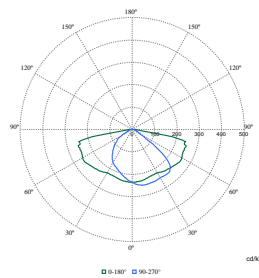

Polar Normal (separate) - BGP713I - 910925868409

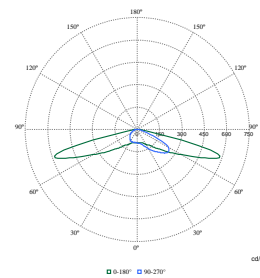

Polar Normal (separate) - BGP713I - 910925868407

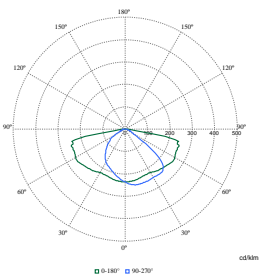

Polar Normal (separate) - BGP702I - 910925868801

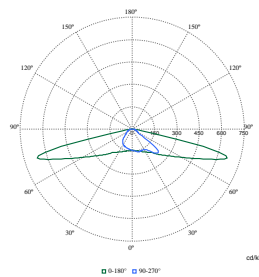

Polar Normal (separate) - BGP704I - 910925866542

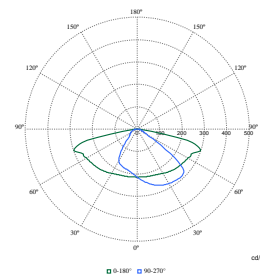

Polar Normal (separate) - BGP702I - 910925866535

Polar Wide Diagrams

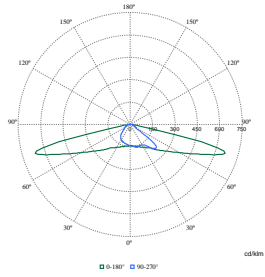

Polar Normal (separate) - BGP7031 - 910925866538

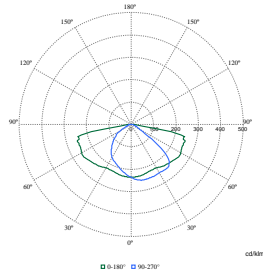

Polar Normal (separate) - BGP7021 - 910925866536

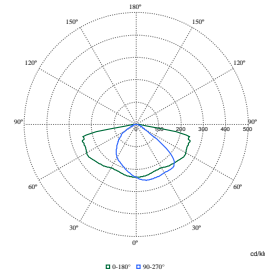

Polar Normal (separate) - BGP7021 - 910925866534

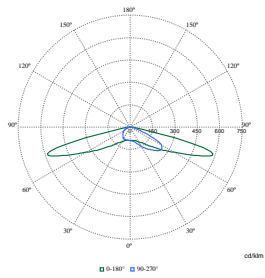

Polar Normal (separate) - BGP7031 - 910925866539

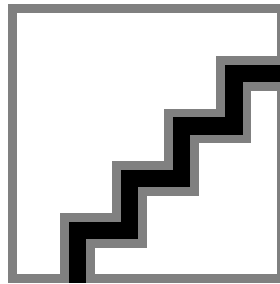

Polar Normal (separate) - BGP7041 - 910925866543

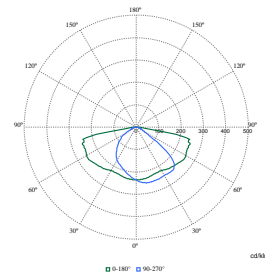

Polar Normal (separate) - BGP7041 - 910925866544

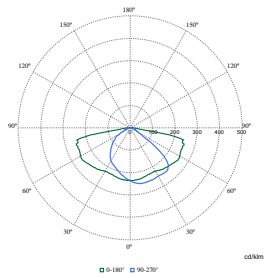

Polar Normal (separate) - BGP7051 - 910925867142

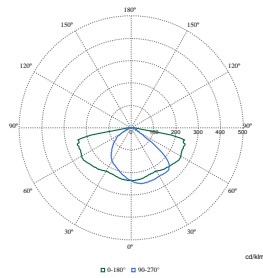

Polar Normal (separate) - BGP7011 - 910925867326

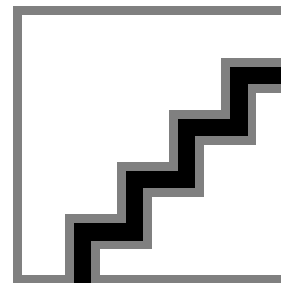

Polar Normal (separate) - BGP7051 - 910925867143

Polar Wide Diagrams

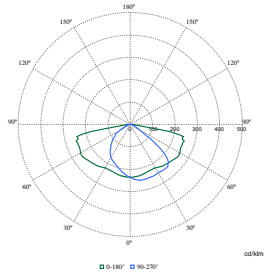

Polar Normal (separate) - BGP7011 - 910925867324

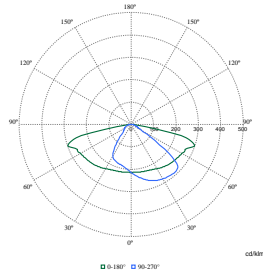

Polar Normal (separate) - BGP7011 - 910925867325

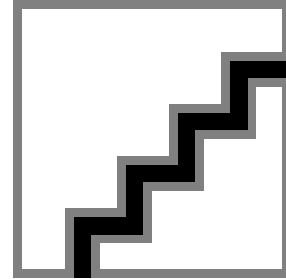

Polar Normal (separate) - BGP7011 - 910925868137

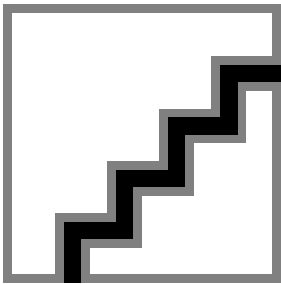

Polar Normal (separate) - BGP7041 - 910925867794

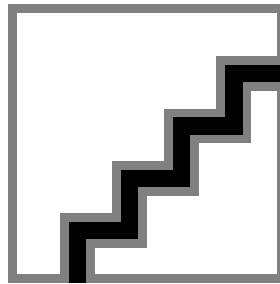

Polar Normal (separate) - BGP7041 - 910925868792

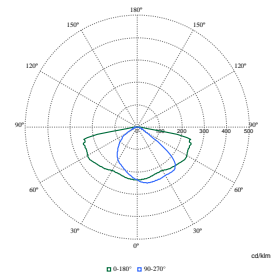

Polar Normal (separate) - BGP7011 - 910925868799

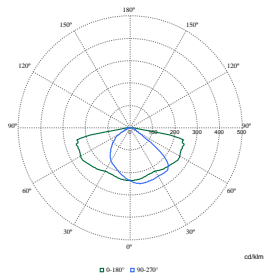

Polar Normal (separate) - BGP7031 - 910925868802

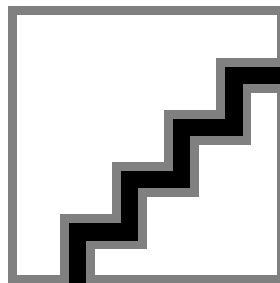

Polar Normal (separate) - BGP7041 - 910925868803

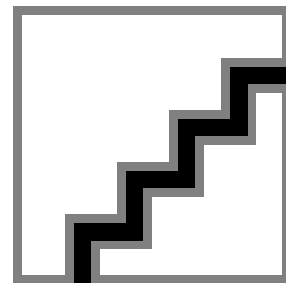

Polar Normal (separate) - BGP7051 - 910925868804

Polar Wide Diagrams

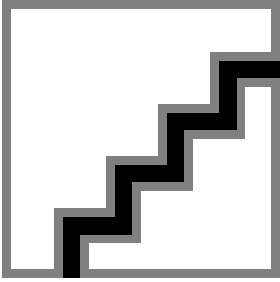

Polar Normal (separate) - BGP702I - 910925867785

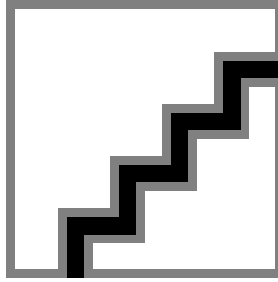

Polar Normal (separate) - BGP703I - 910925867788

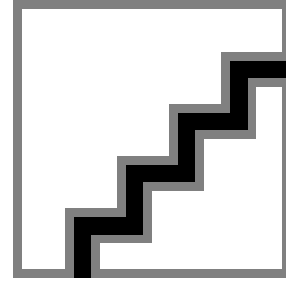

Polar Normal (separate) - BGP703I - 910925867791

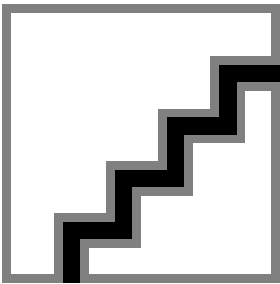

Polar Normal (separate) - BGP703I - 910925867790

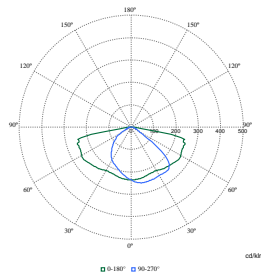

Polar Normal (separate) - BGP703I - 910925867834

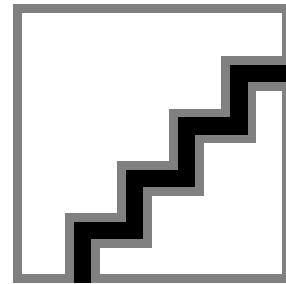

Polar Normal (separate) - BGP704I - 910925867835

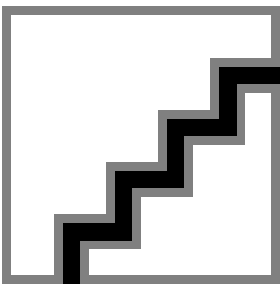

Polar Normal (separate) - BGP701I - 910925868225

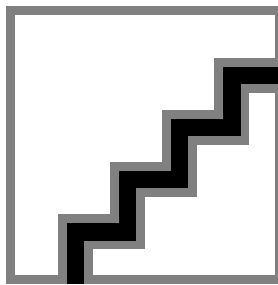

Polar Normal (separate) - BGP705I - 910925868226

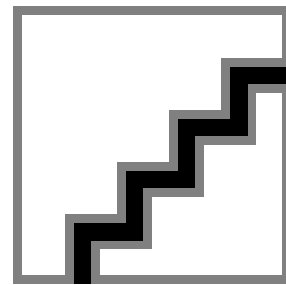

Polar Normal (separate) - BGP702I - 910925870005

Polar Wide Diagrams

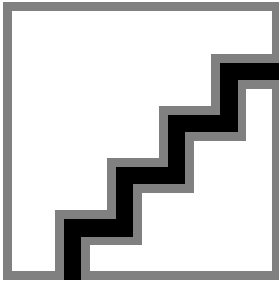

Polar Normal (separate) - BGP703I -
910925870008

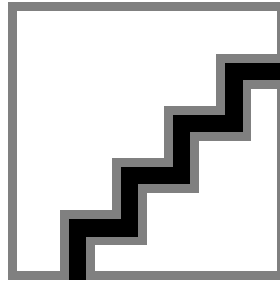

Polar Normal (separate) - BGP705I -
910925870017

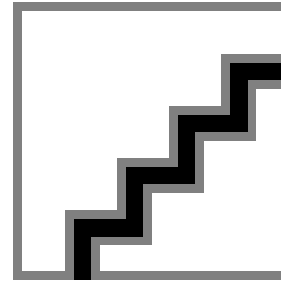

Polar Normal (separate) - BGP713I -
910925870011

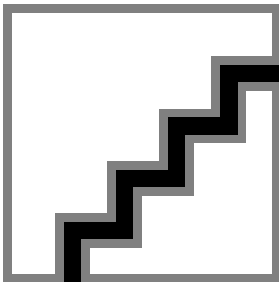

Polar Normal (separate) - BGP701I -
910925870002

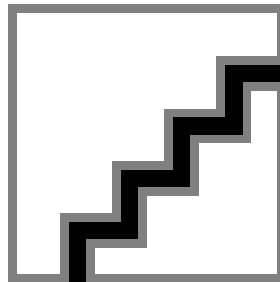

Polar Normal (separate) - BGP704I -
910925870014

