

# Removability Introduction on Disposal at End of Life

Image of  
Product

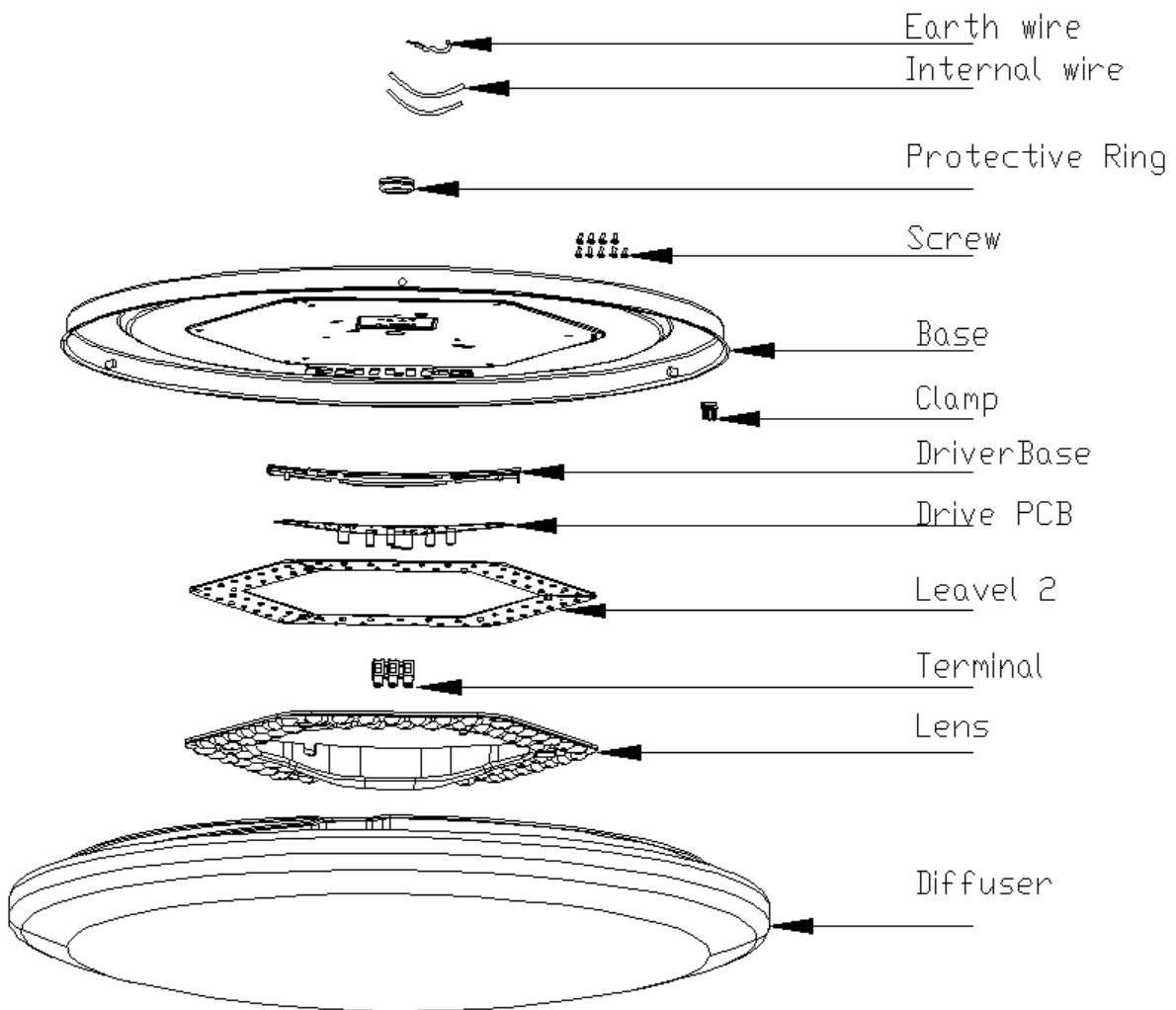











## Composition Explanation –Morrie 36W



# Removability Introduction on Disposal at End of Life

Image of  
 Product

## Composition Explanation –Morrie 36W

Plastic part	Electrical part	Metal part
DriverBase 	Leavel 2 	Base 
Lens 	Drive PCB 	Screw 
Diffuser 	Earth wire 	
Clamp 	Internal wire 	
Protective Ring 	Terminal 	

### C Recommendation on disposal

- Plastic part :reuse and recycling
- Electrical part :incineration and disposal
- Metal part :recycling
- Battery part: recycling

# Removability Introduction on Disposal at End of Life

## Composition Explanation –Morrie 36W

1

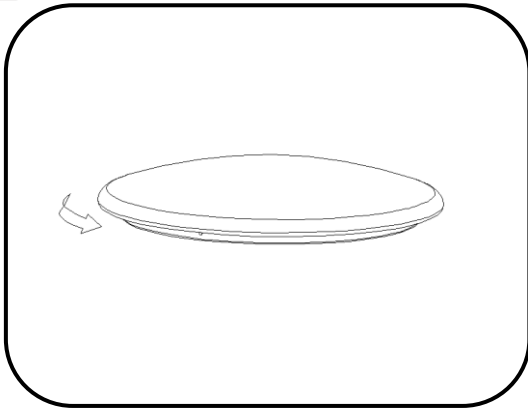

2

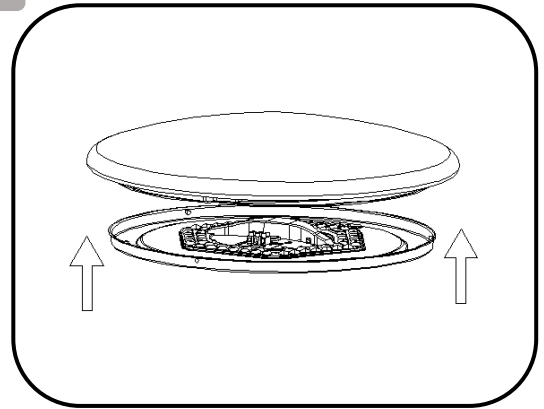

3

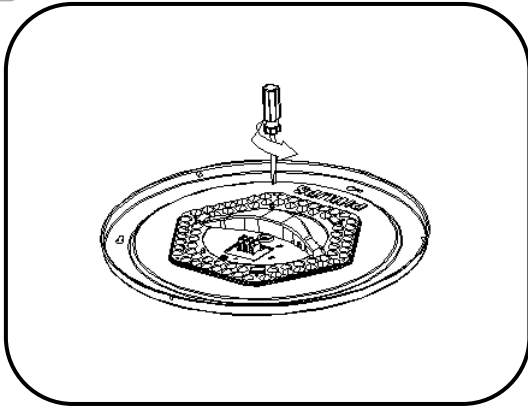

4

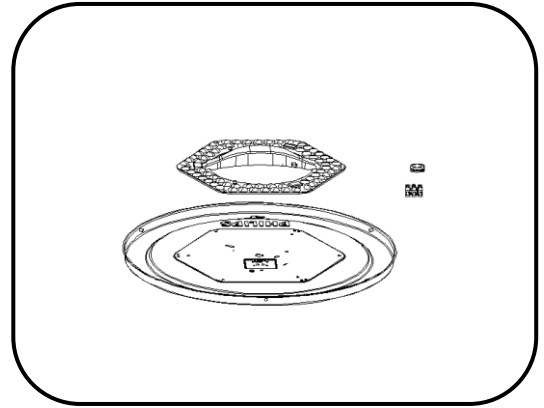

5

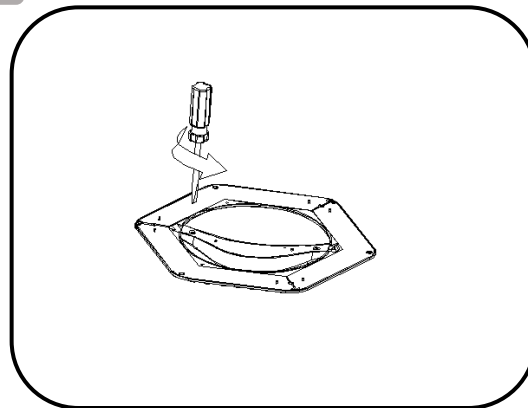

6

