

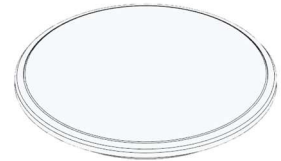

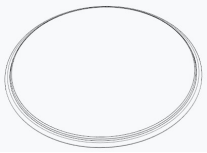

Dismantling Recommendation on Disposal at End of Life

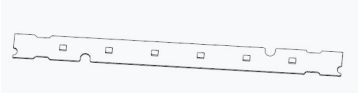
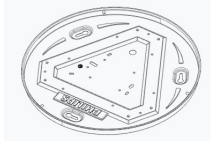

•Composition Explanation –Ceiling

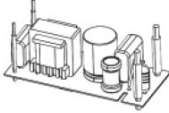
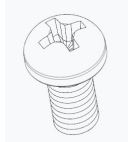
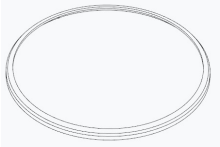
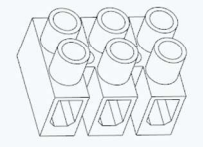
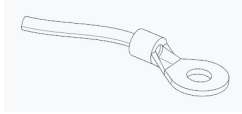
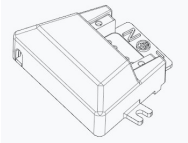
Plastic part	Electrical part	Metal part
Cover 	PCB 	Base 
Lens 	Drive 	Screws 
Face ring 	Connector 	Ground wire 
Driver box 	Wire 	Other small metal part

Dismantling

- Steps: refer to disassembly instruction
- Type: without permanent damage

Recommendation on disposal

- Plastic part :reuse and recycling
- Electrical part :incineration and disposal

1、Dismantling:

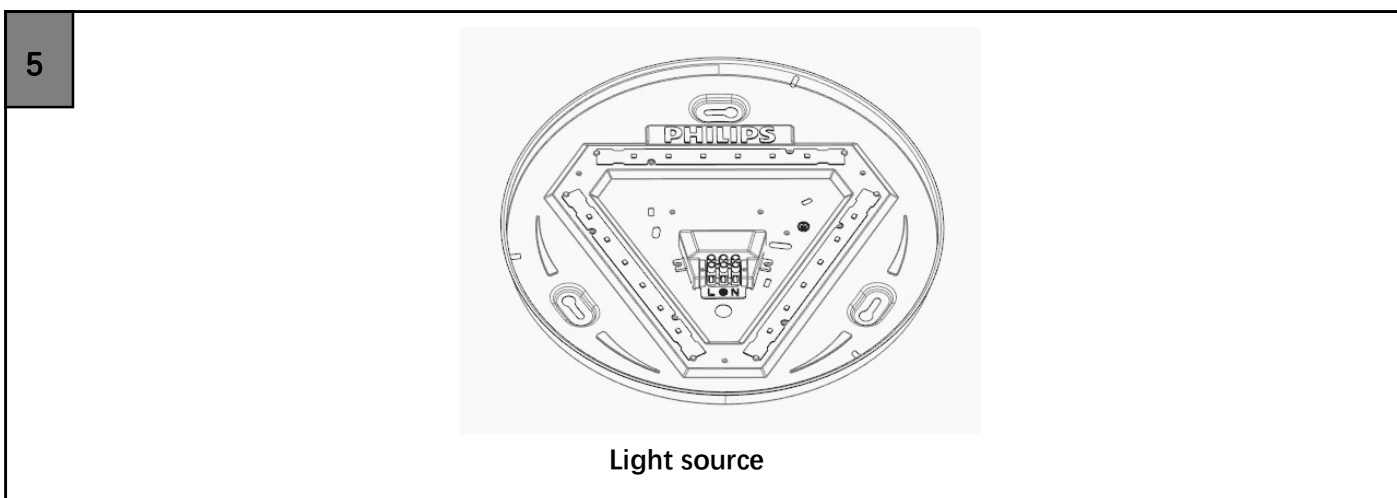
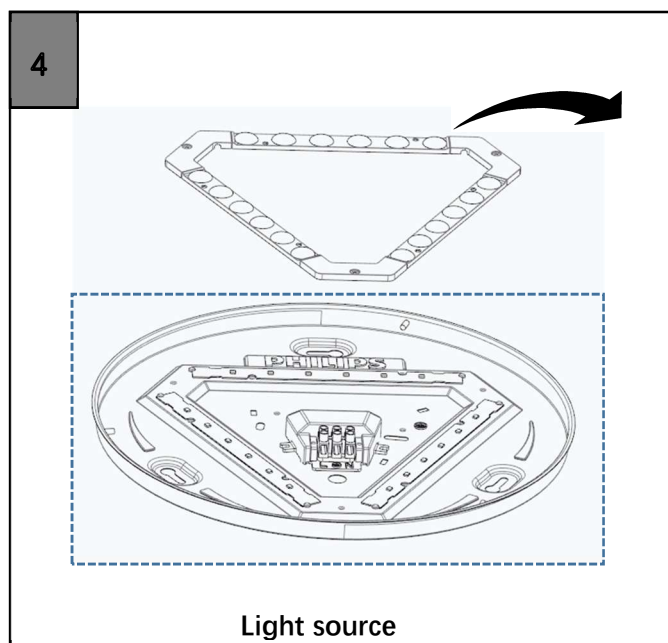
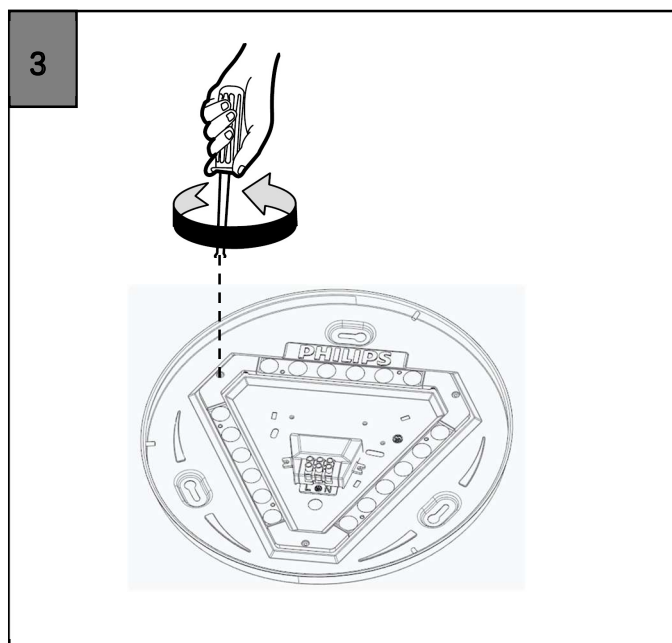
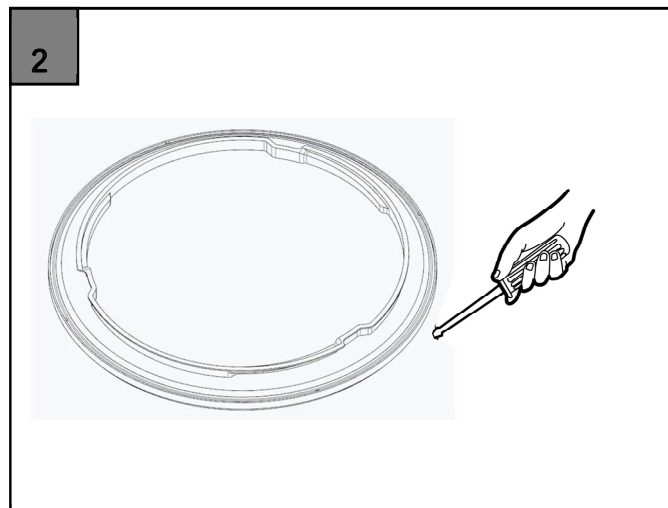
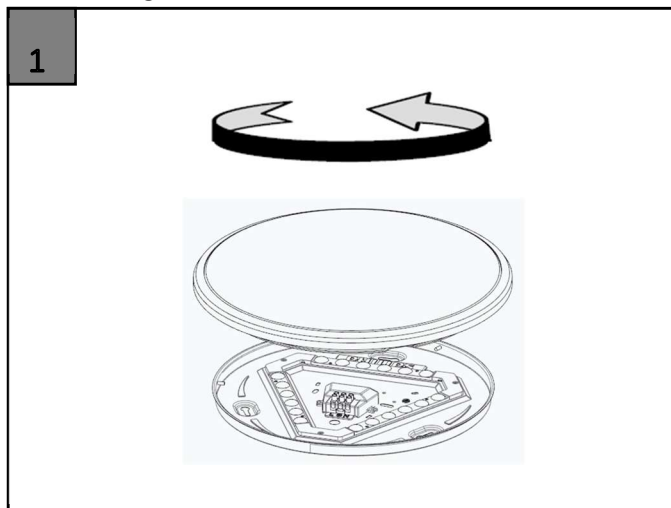

2、Light Source Replaceable description

Non-user replaceable:

a. Old Light Source Disassembly Instruction

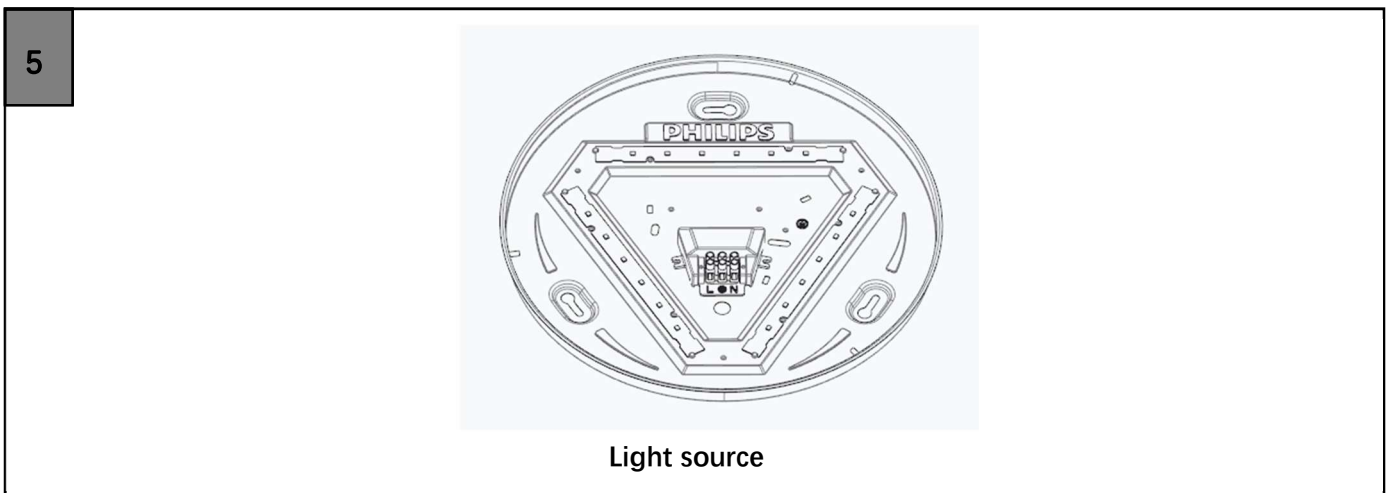
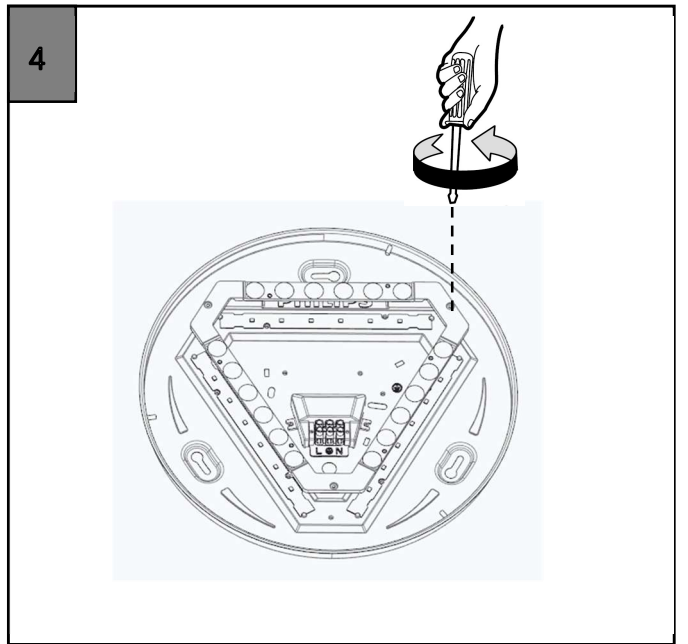
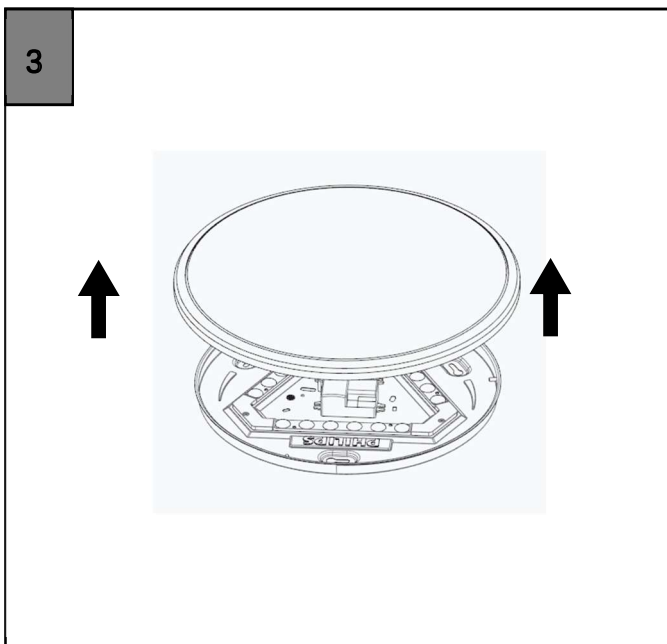
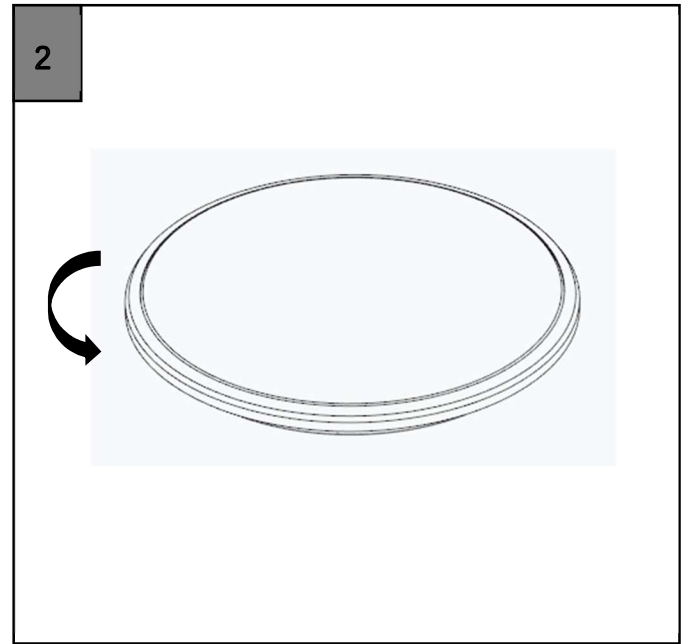
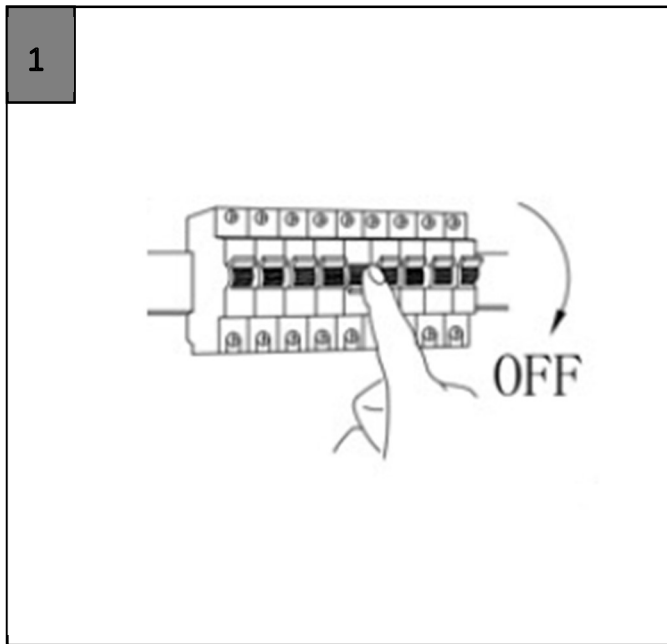

b. New Light Source Assembly Instruction:

