

## Dismantling Recommendation on Disposal at End of Life

### Composition Explanation

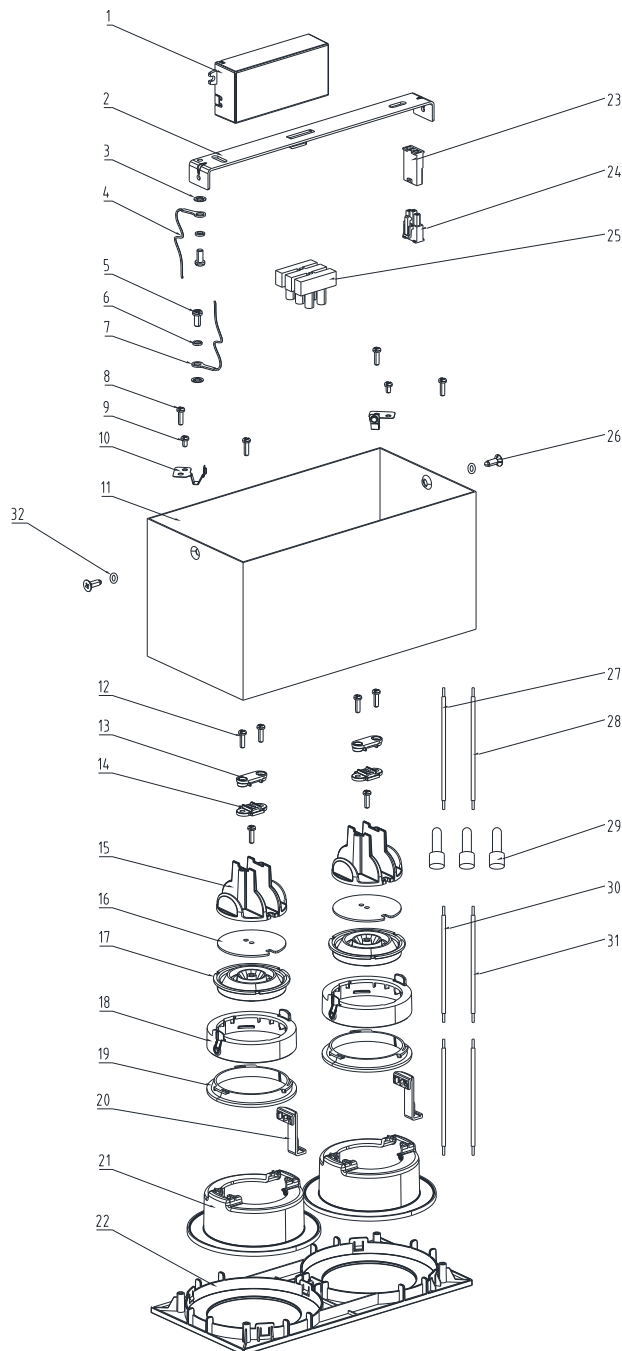

# Dismantling Recommendation on Disposal at End of Life

## Composition Explanation

No.	Components	Specifications	Unit	Quantity
1	PYS 10W driver		PCS	1
2	G17536 bracket	Zinc coated	PCS	1
3	φ4 teeth washer	Zinc coated	PCS	2
4	Earthing wire	UL 1332 20AWG	PCS	1
5	M4*6mm screw	Copper coated	PCS	2
6	φ4 spring washer	Zinc coated	PCS	2
7	Earthing wire	UL 1332 20AWG	PCS	1
8	BT3*8 screw	Zinc coated	PCS	5
9	M3*5mm screw	Zinc coated	PCS	2
10	G17516 limiter		PCS	2
11	G17536 body	Metal sheet	PCS	1
12	M3*10mm screw	Zinc coated	PCS	4
13	G17516 upper strain relief	PA6	PCS	2
14	G17516 lower strain relief	PA6	PCS	2
15	G17516 heat sink	ADC12	PCS	2
16	YL20-7-14DB4W-C017		PCS	2
17	G17516 lens	PC	PCS	2
18	G17516 head	ABS	PCS	2
19	G17516 ring	ABS	PCS	2
20	G17516 plastic limiter	ABS	PCS	2
21	G17516 head holder	PC-L1225-Z100+ABS-GE150,钛白	PCS	2
22	G17536 cover	ABS-GE150,本色	PCS	1
23	5557-3P		PCS	1
24	5559-3R		PCS	1
25	T06-3P		PCS	1
26	M4*12 screw	Zinc coated	PCS	2
27	FEP brown wire	VDE0.5mm <sup>2</sup>	PCS	1
28	FEP blue wire	VDE0.5mm <sup>2</sup>	PCS	1
29	Closed end connector		PCS	3
30	FEP red wire	UL 1332/22AWG	PCS	2
31	FEP black wire	UL 1332/22AWG	PCS	2
32	φ4 teeth washer	SS	PCS	2

## Dismantling Recommendation on Disposal at End of Life

### Dismantling

- Type: Without permanent damage

### Recommendation on Disposal

- Plastic part: Reuse and Recycling
- Electrical part: Incineration and disposal
- Metal part: Recycling

### Light source dismantling process

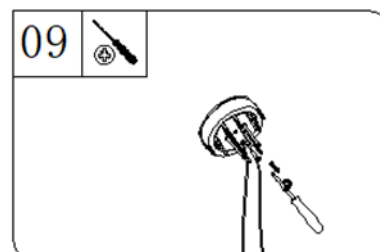
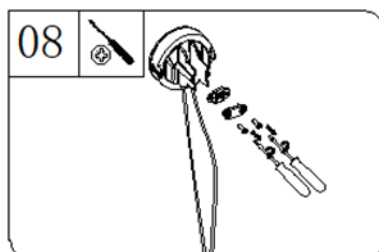
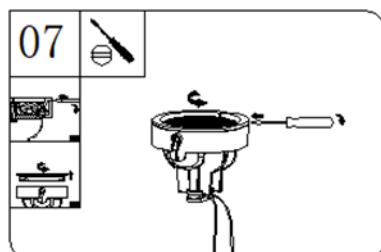
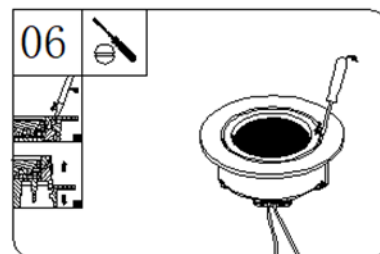
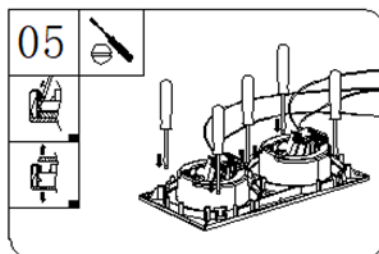
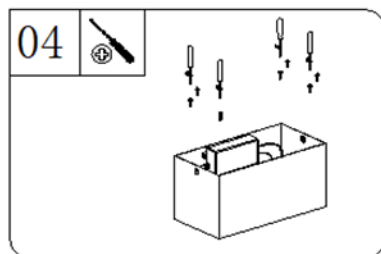
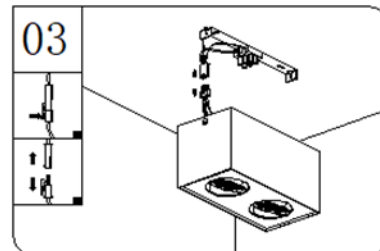
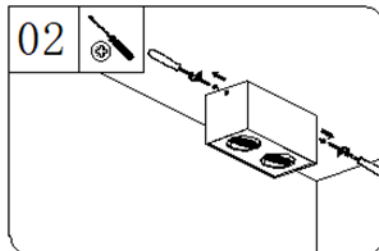
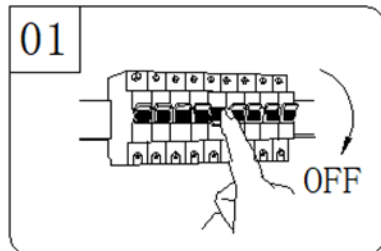

## Dismantling Recommendation on Disposal at End of Life

