

3D-PRINTED TRACK SYSTEMS

LIGHTOLIER

Break free from ordinary lighting



From retail to hospitality – and beyond. Expect more from your lighting!

LumaShine Series

The LumaShine Series is designed for businesses that demand exceptional lighting without compromising on sustainability, speed, or performance. Perfect for high-volume retail and hospitality spaces, Shine delivers a seamless fit for your unique brand.



With Lightolier's track lighting, it's not just about illumination - it's about telling your brand's story through light.

Kate Brown

NCIDQ, LEED AP BD+C | Owner & Creative Director | IRIDIO

LumaShine Series

Available in three colors – black, white, and grey.

High efficacy (up to 120 lm/W)

Strong optical performance with AccuRender technology

Compact and timeless 3" aperture design

Sustainable production using bio-circular materials:
at least 65% recycled or biocircular materials

YOUR BENEFIT...

...by choosing LumaShine Series.

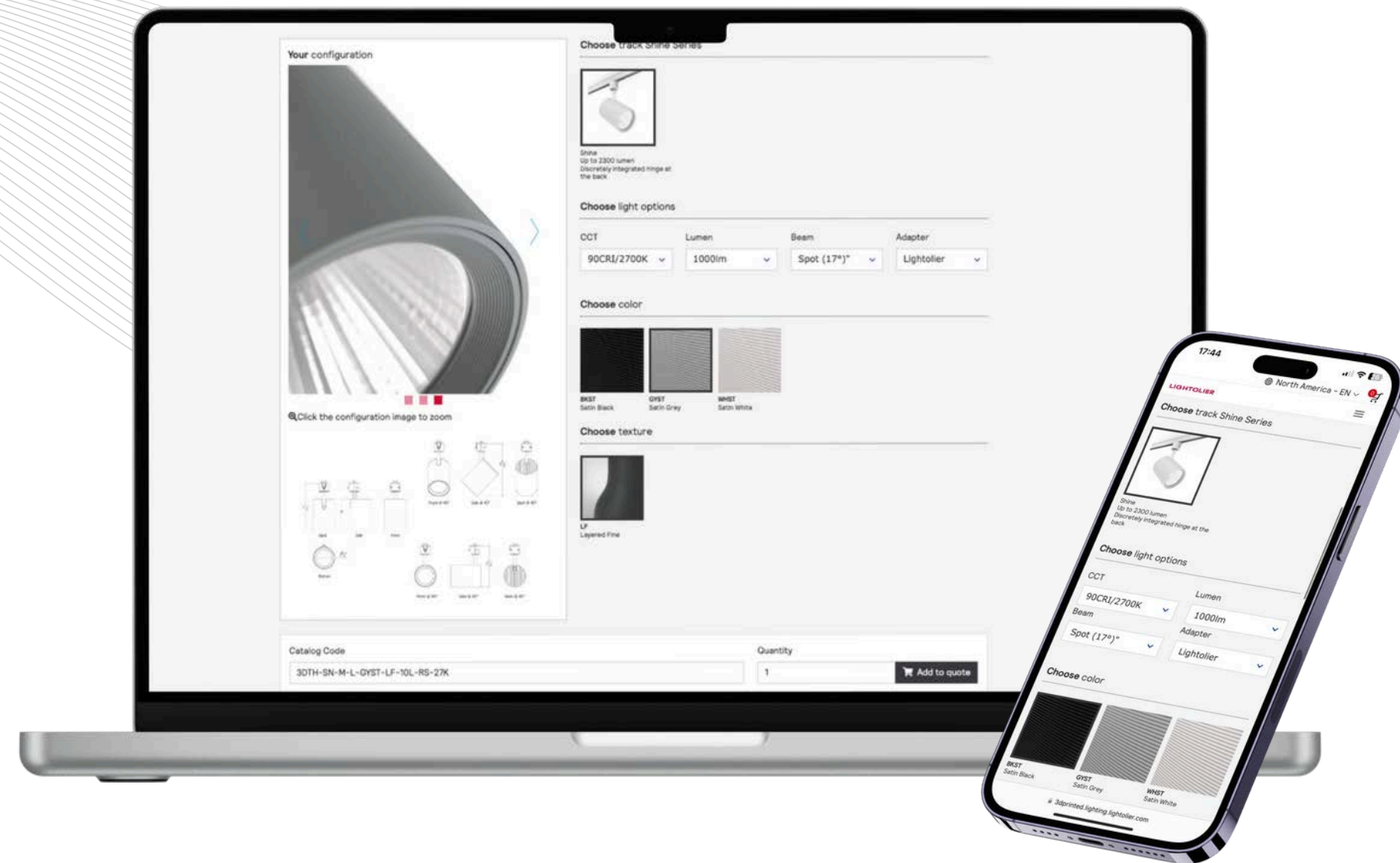

1. DESIGN

- Customizable colors.
- Compact design integrates seamlessly into unique spaces.

2. SUSTAINABILITY

- Made with 65% bio-circular materials.
- 3D-printed for a reduced carbon footprint.
- Circular design for easy recycling at the end of its lifecycle.

3. PERFORMANCE

- High CRI (90+) with AccuRender technology for excellent color rendering.
- Lumen maintenance (L90B50 @66,000 hours) for consistent lighting over time.

4. TIMELINESS

- Designed and delivered quickly to meet operational needs.
- Assembled and manufactured in the United States.



Eco-Conscious, Circular, and Transparent

We're helping businesses meet their sustainability goals without sacrificing performance or style.

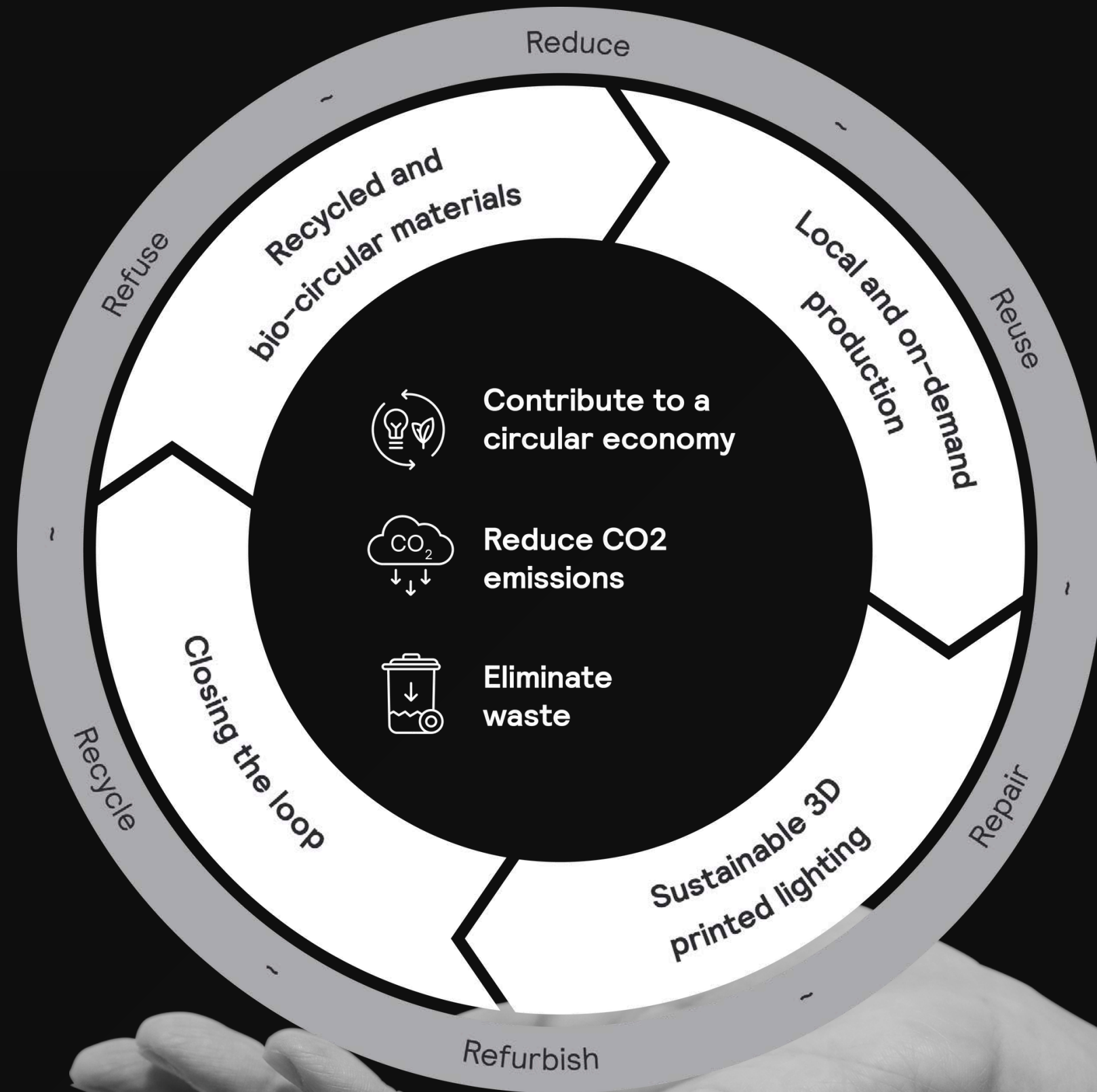



Visuals Library



Portfolio





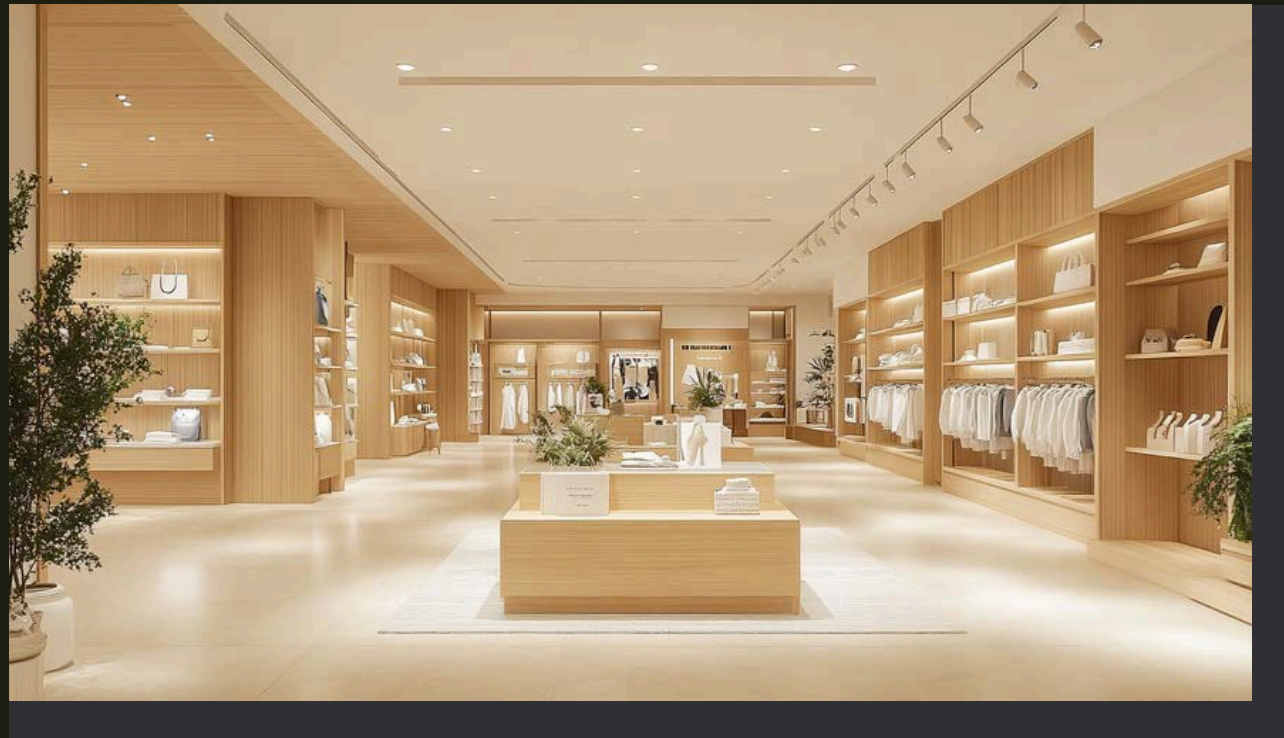

Retail: Food & Drug Store

LIGHTOLIER



Hospitality: Reception Area

LIGHTOLIER

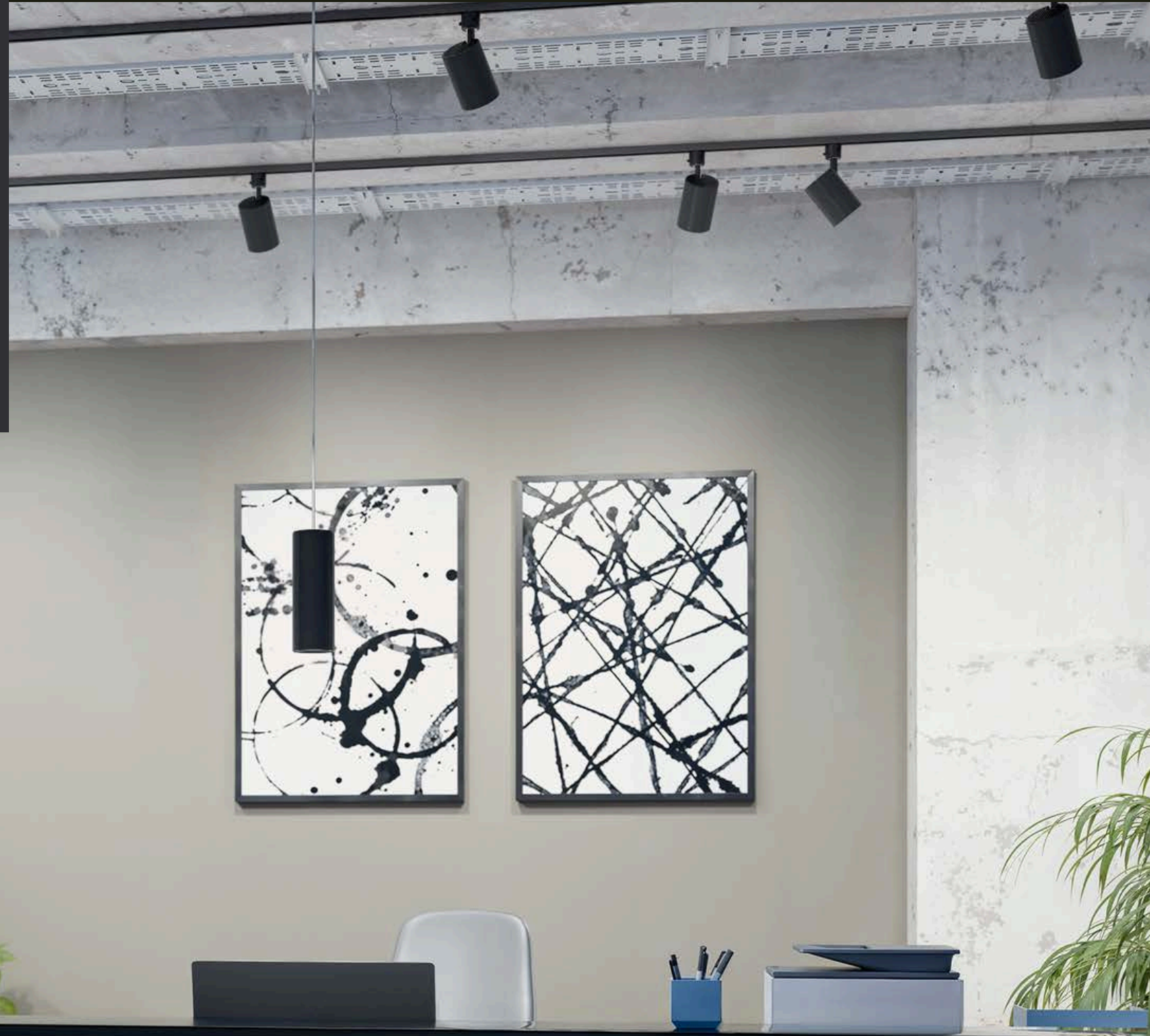
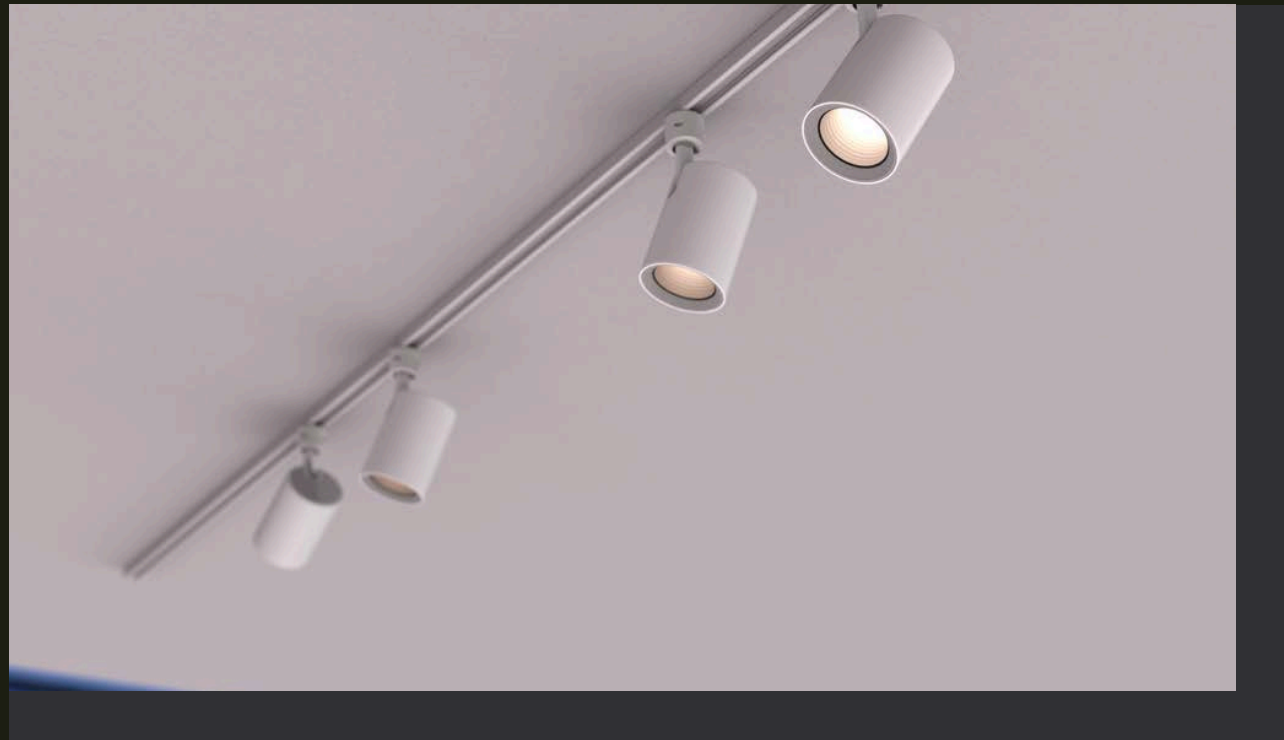

LumaShine Series

3D Track Heads (1000lm, 1500lm, 2300lm)



interact ready.



Declare.

Features

- **Customizable:** choose from a wide variety of configurations.
- **Sustainable:** 3D Printed products produce less carbon emissions when compared to traditional, conventional luminaires.
- **Local production:** Printed and assembled in Littlestown, PA.
- **Quick delivery:** Created on demand and shipped in weeks.
- **Lifetime:** L90/B50 Lumen Maintenance at 66,000 hours and L70/B50 >110,000 hours.

Dimming Compatibility

Trailing edge (ELV) dimming compatible

SELV-300P	Lutron Skylark (100-7%)
DVELV-300P	Lutron Diva (100-7%)
6615-P	Leviton Decora (100-12%)

Electrical

Efficacy: Up to 120 lm/W
Track Mount: Standard Lightolier track adapter
Input Voltage: 120V
Frequency: 50/60Hz
Power Factor: 0.9
Control: ELV dimming

Mounting

Track Adapters: Lightolier, Juno or Halo mounting track options
Horizontal rotation: 350°
Vertical tilt: 90°

Labels

cULus listed, 5 year warranty, IP20, RoHS & DLC Premium rated
Declare. LBC Red List Approved.

Configuration Page

Dimensions

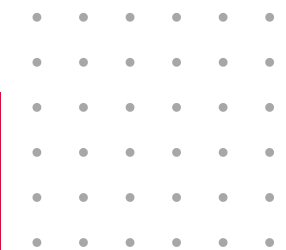
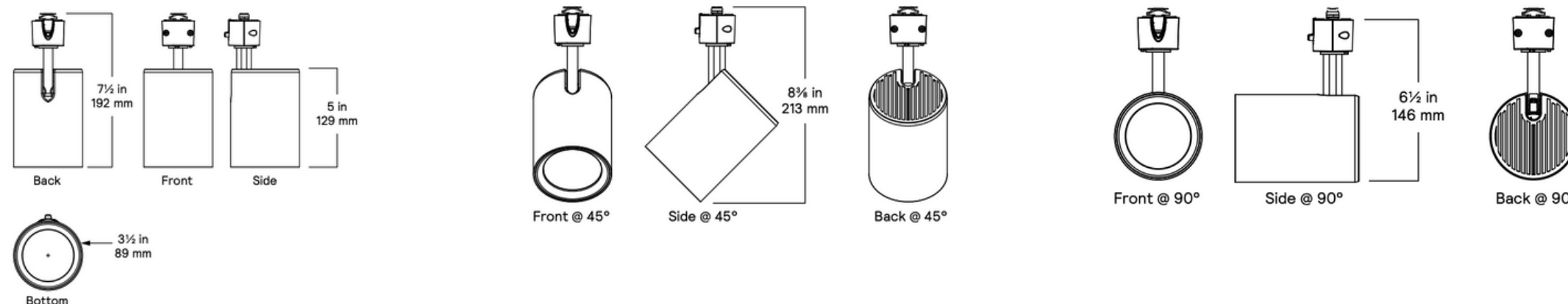

MS Series

The MS Series Track Head provides sleek accent lighting with CRI 90 AccuRender Technology for accurate color representation. Made from bio-circular polycarbonate, it offers various colors, textures, and lumen options up to 2300 lm. Its specification-grade optics and high Center Beam Candle Power make it suitable for retail, hospitality, and office spaces.

The beauty of the MS Series track heads is the low install cost and flexibility to move the fixtures where the light is most needed in the field. It was a win-win from a budget and manipulation standpoint.

Kate Brown

NCIDQ, LEED AP BD+C | Owner & Creative Director | IRIDIO



Efficacy: up to 111 lm/W.

Customizable: choose from a wide variety of colors.

Sustainable: 3D Printed products produce less carbon emissions when compared to traditional, conventional luminaires.

Standard CRI 90 with 2700K, 3000K, 3500K, and 4000K CCT options.

Lifetime: L90/B50 Lumen Maintenance at 66,000 hours.

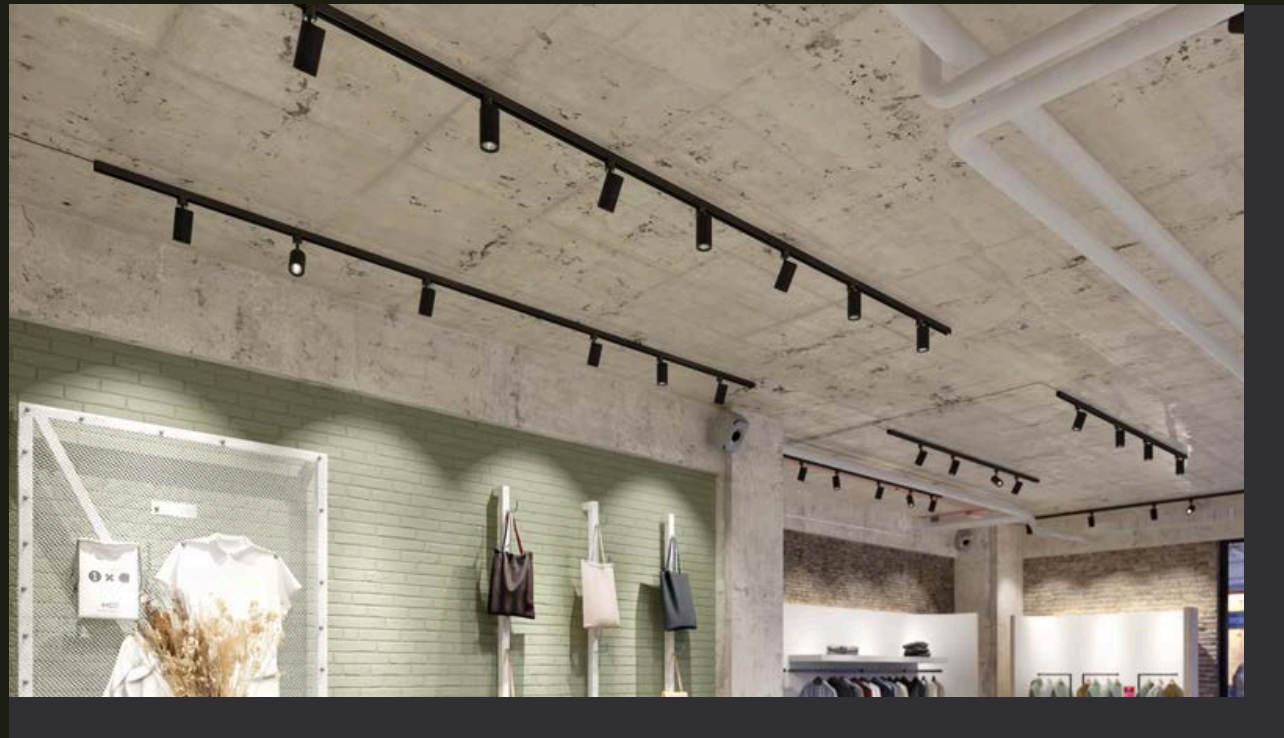

MS Series

3D Track Heads (1000lm, 1500lm, 2300lm)



interact ready.



Declare.

Features

- **Customizable:** choose from a wide variety of colors.
- **Sustainable:** 3D Printed products produce less carbon emissions when compared to traditional, conventional luminaires.
- **Local production:** Printed and assembled in Littlestown, PA.
- **Quick delivery:** Created on demand and shipped in weeks.
- **Lifetime:** L90/B50 Lumen Maintenance at 66,000 hours.

Dimming Compatibility

Trailing edge (ELV) dimming compatible

SELV-300P	Lutron Skylark (100-7%)
DVELV-300P	Lutron Diva (100-7%)
6615-P	Leviton Decora (100-12%)

Electrical

Efficacy: Up to 111 lm/W
Track Mount: Standard Lightolier track adapter
Input Voltage: 120V
Frequency: 50/60Hz
Power Factor: 0.9
Control: ELV dimming

Mounting

Track Adapters: Lightolier, Juno or Halo mounting track options
Horizontal rotation: 350°
Vertical tilt: 90°

Labels

cULus listed, 5 year warranty, IP20, RoHS & DLC Premium rated
Declare. LBC Red List Approved.

Configuration Page

Dimensions

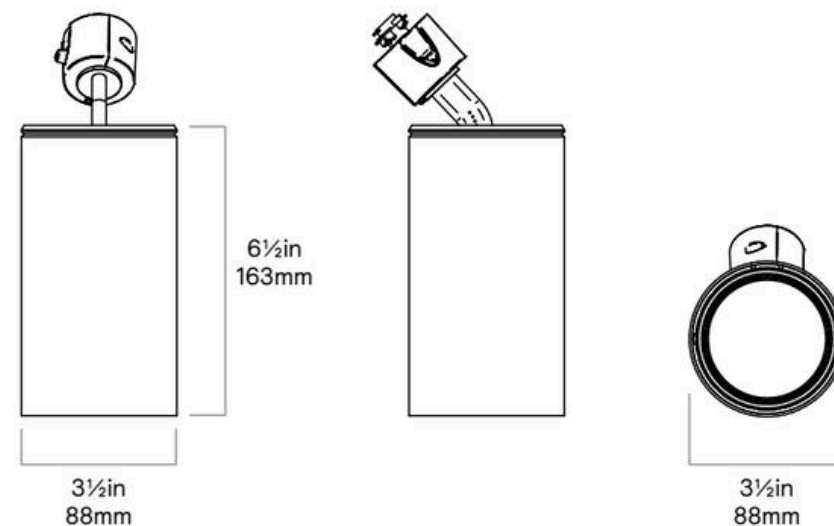

LIGHTOLIER

Superior partner in lighting.