

NatureConnect

by @signify

Commissioning guide

NatureConnect link & Interact

June, 2024



Introduction

The NatureConnect system is based on biophilic design principles, which uses elements of nature and natural analogues in indoor spaces to make people feel happy and healthy. Unlike traditional lighting which focuses on visual benefits, NatureConnect additionally brings the biological and emotional benefits of lighting. It reconnects us with the constant cycles and variations of nature for comfortable, engaging and attractive indoor environments.

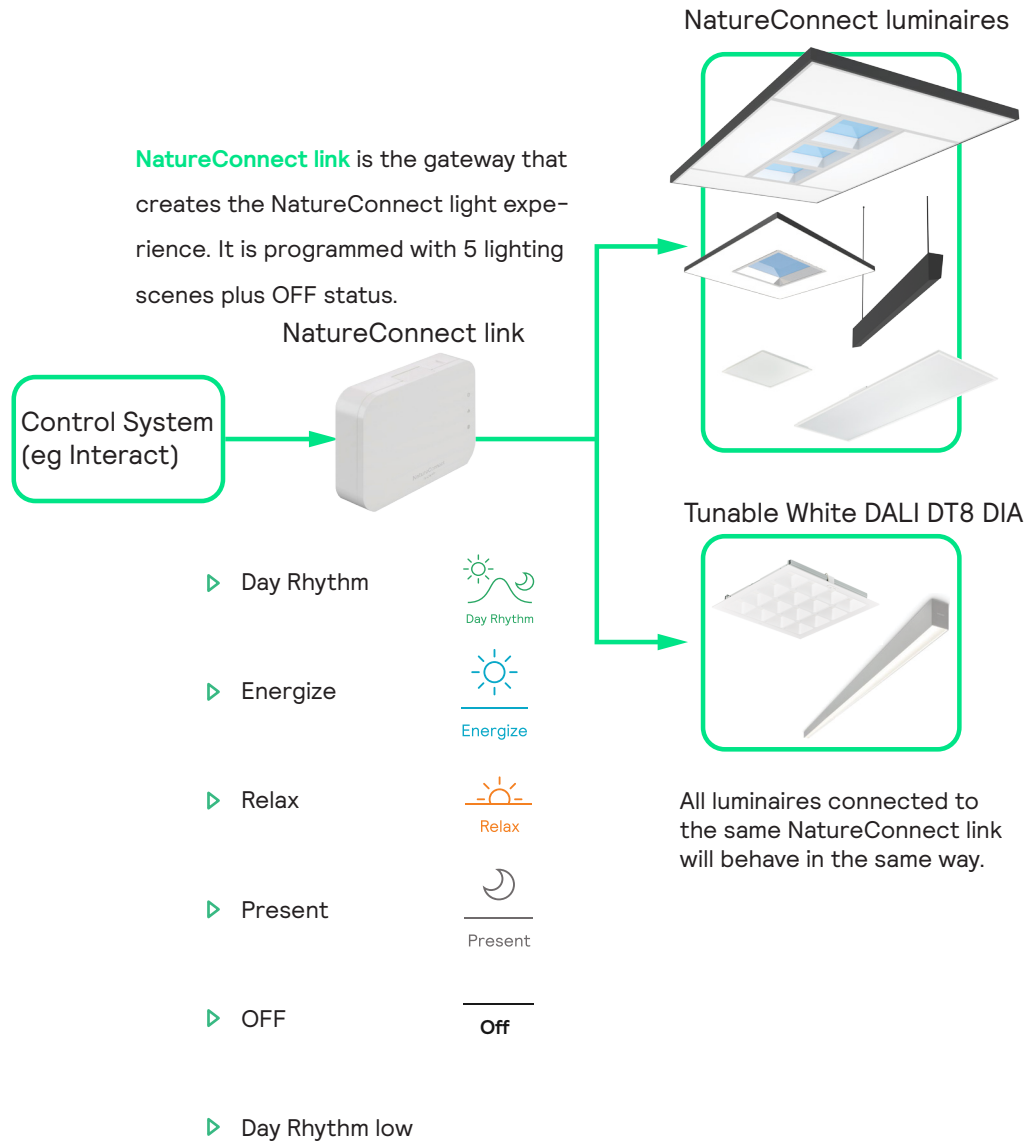

The best NatureConnect experience is achieved combining NatureConnect link with presence sensors and user interfaces.

NatureConnect switch



Interact switch with NatureConnect icons (910505103545)

- ▶ Wireless, battery free
- ▶ Scene and Off buttons with icons and text for ease of use
- ▶ High quality engraving for long durability

Presence sensors

helps to reduce the power consumption. They can be programmed in a way that when no occupancy is detected, inside the room, they send the signal to the NatureConnect link, to activate “Day Rhythm low” scene or to turn off the luminaires. When presence is detected it goes automatically to “Day rhythm”.

Commissioning

You will need a device that supports Interact commissioning app. (e.g. smartphone or a tablet) with Bluetooth technology.

For more info check:

<https://sme.interact-lighting.com/web/help/prf-pra/2.3/install/commissioning.html>

1 Test the connection with the luminaires by pressing the service button

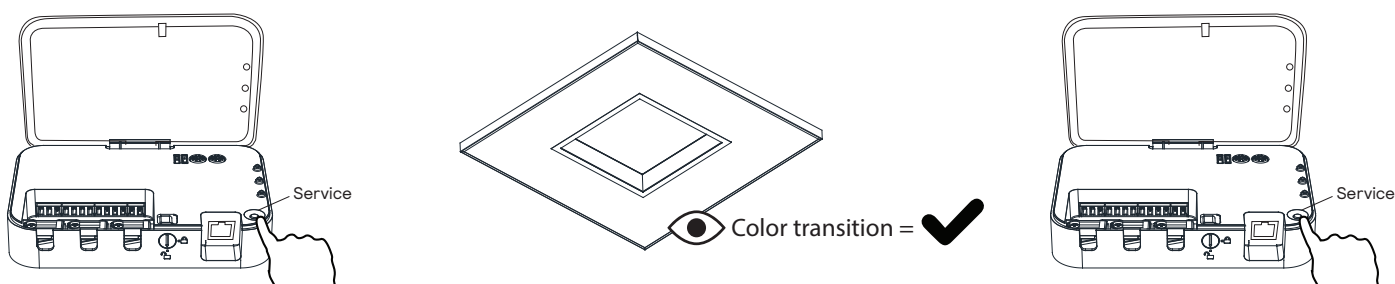

① Press the “service” button to start the test

② Check luminaires

③ Press the “service” button to finish the test

2 Time configuration - two methods

1 Connect (temporarily) to a wired network that has access to internet/NTP

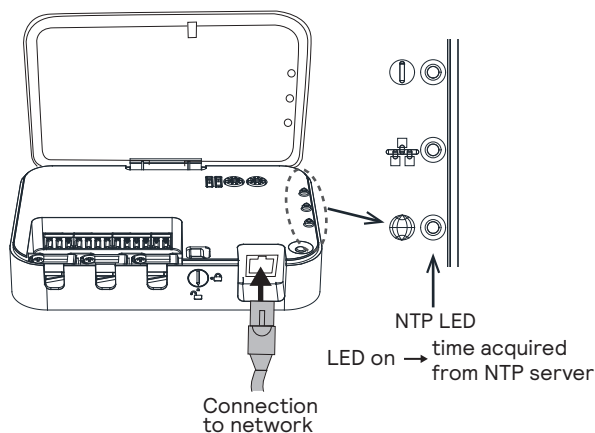

2 Manually set the time with Windows configuration app

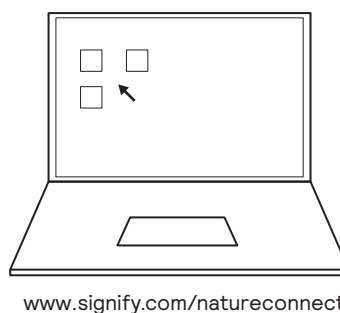

! Time is already configured from production date 23W48. Please check on the box label.

! Once the time is set, NatureConnect link will keep the time without a permanent internet connection.

Commissioning with interact PRF as Lighting Control System

1 Download the **interact** office app and create an account

Download the Interact Pro app



GET IT ON Google Play

Download on the App Store



interact

Log in to Interact Pro

Email address

Password 

[Forgot password](#)

Get started

By proceeding you agree with the [Terms of usage](#)

Are you an installer company and not yet registered?

Request access

2 Create and structure a new project

Create a project

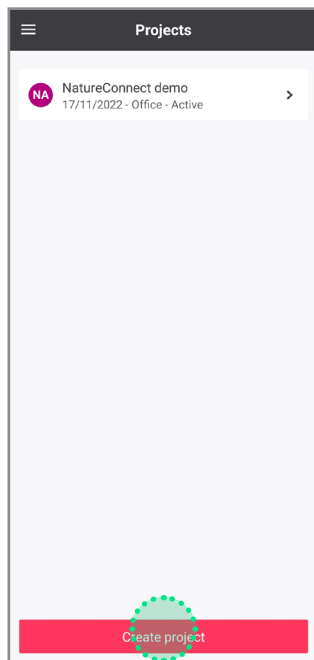
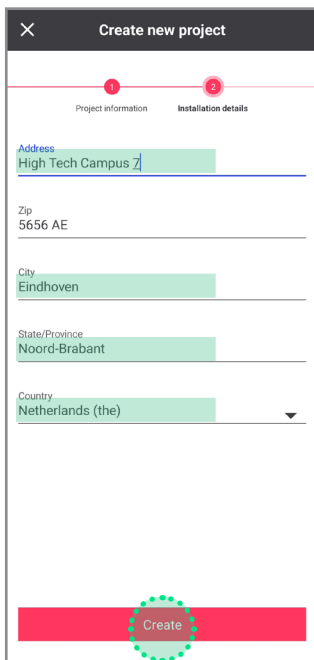
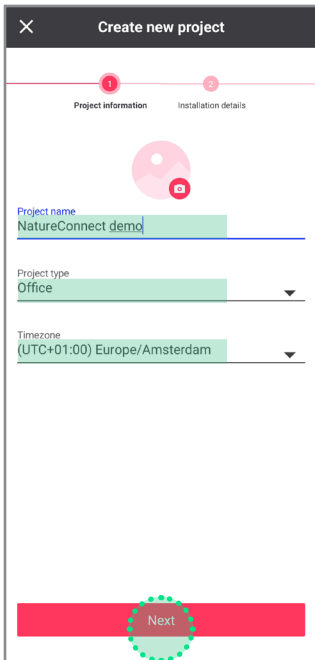
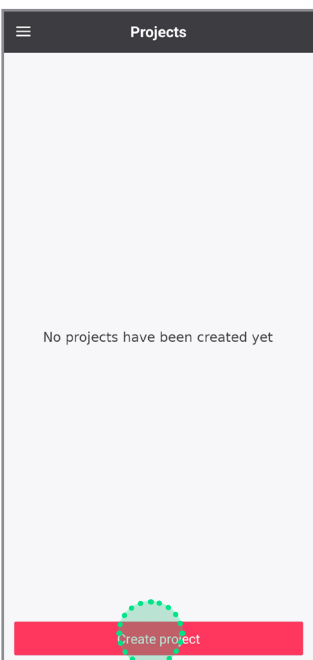

Fill in the fields and open the new project just created.

Create a Light Network

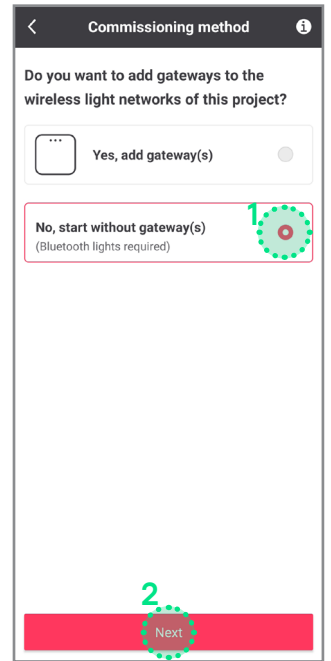
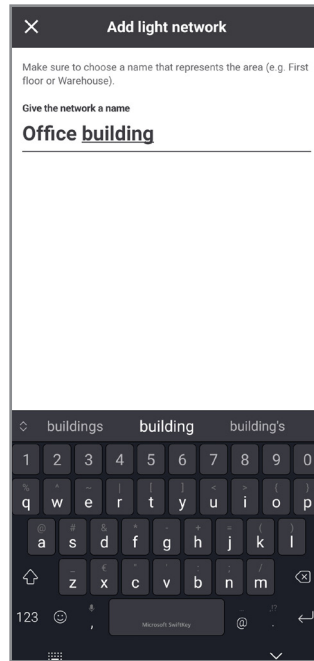
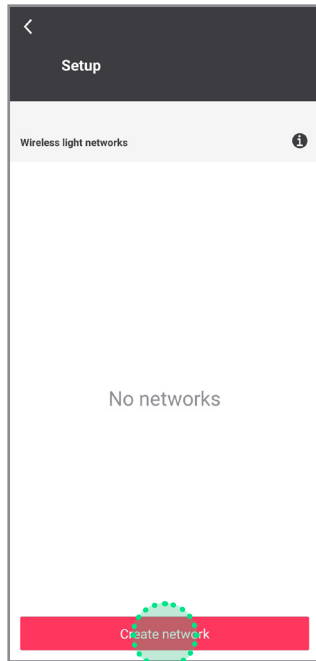
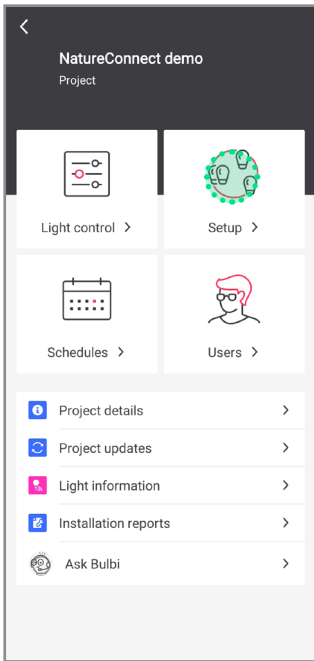

Add a group

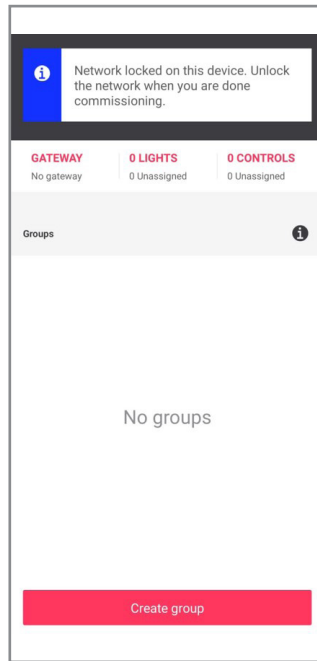
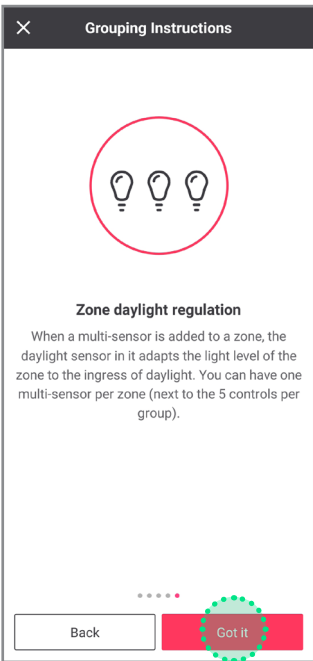
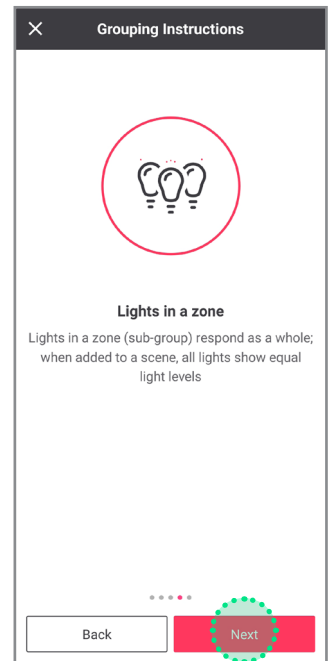
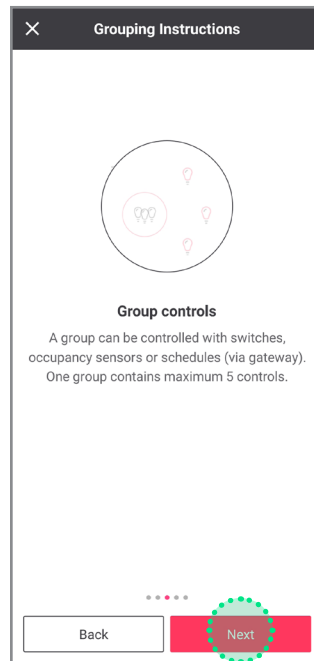
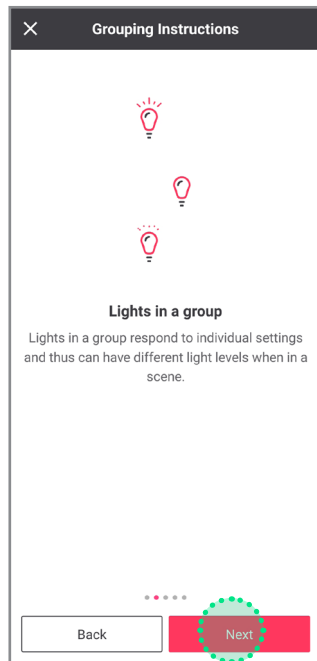
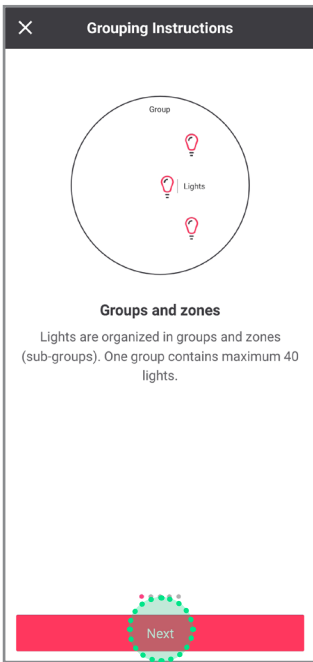

3

Reboot NatureConnect link before proceeding with commissioning

! Only needed if production date is before 23W48

Unplug the connector, wait 10 seconds and reconnect.

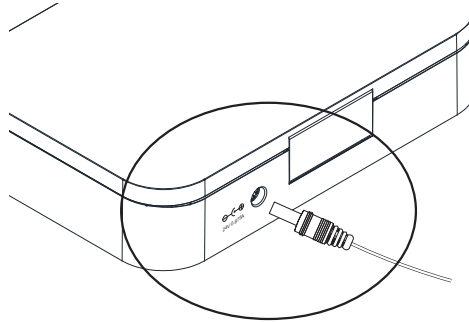

! Wait for the device to start, before proceeding with the next steps. This will take minimum 5 minutes.

4

Find and assign one or more NatureConnect link that belong to the same group.

Stand close (2 m ca.) to the SNS210 connected to the NatureConnect link. (Bluetooth must be active on your device.)

Tab **Light**: click on **Assign lights**

It will be found as e.g.: **Philips luminaire - ****** or **NatureConnect link - ******.

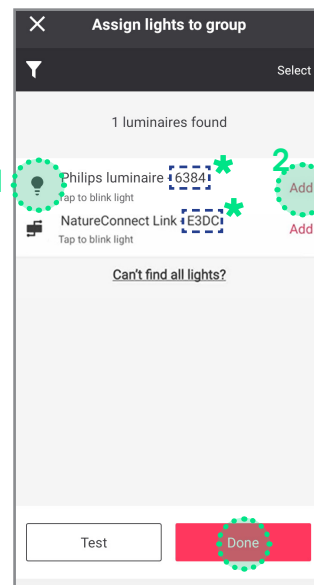
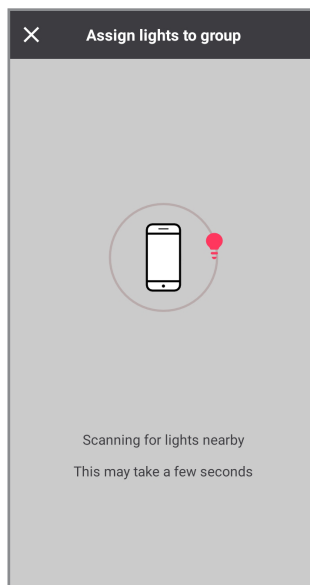
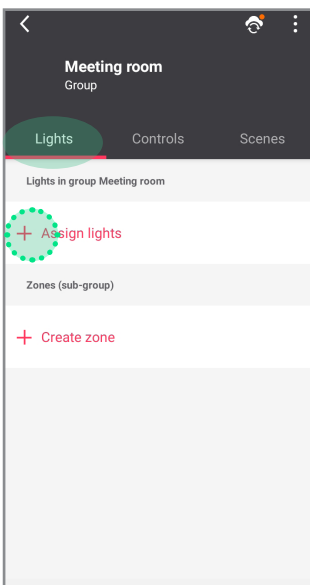

* This number is different for each installation

1 Click the left icon to identify the discovered NatureConnect link and to blink the connected luminaire(s).

2 Click the add button for each NatureConnect link you would like to add to the same group.

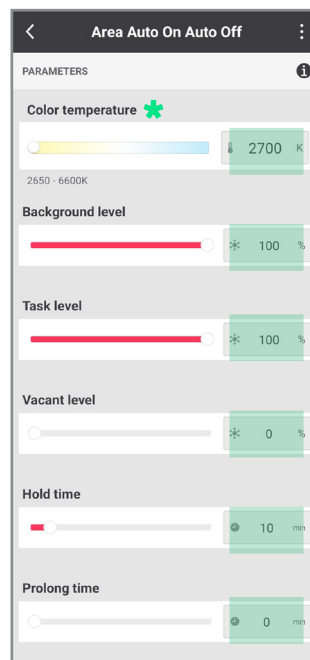
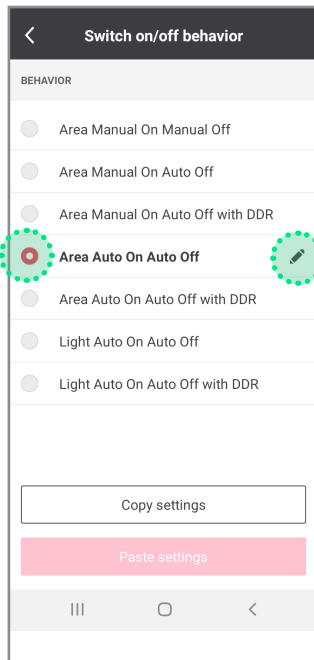
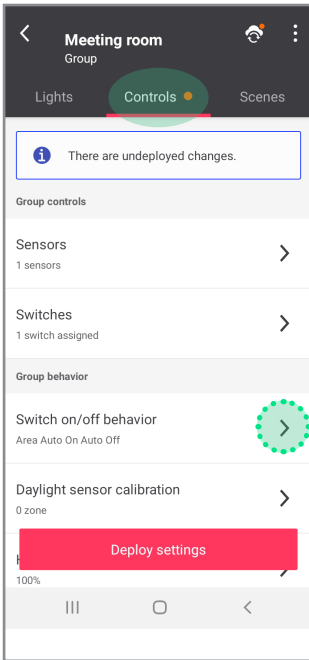
Tab Controls

Follow below steps:

- 1 Set CCT to 2700 K
▶ Press "enter" or "OK"
- 2 Set Background to 100%
▶ Press "enter" or "OK"
- 3 Set Task to 100 %
▶ Press "enter" or "OK"
- 4 Set Vacant to 0 %
▶ Press "enter" or "OK"
- 5 Set Hold time to 10 min
▶ Press "enter" or "OK"
- 6 Set Prolong time to 0 min
▶ Press "enter" or "OK"

* If color temperature slider is missing, follow the procedure indicated in the paragraph B in the Problem Solving chapter.

Optional: how to add battery power motion sensor

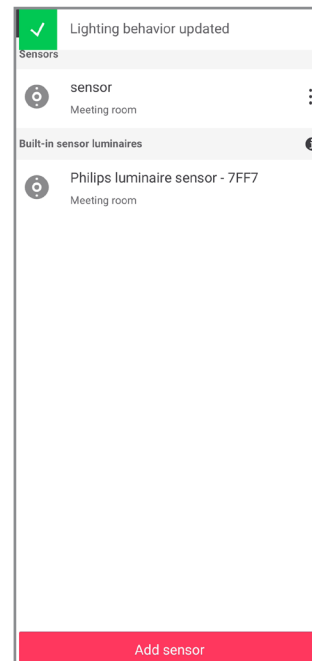
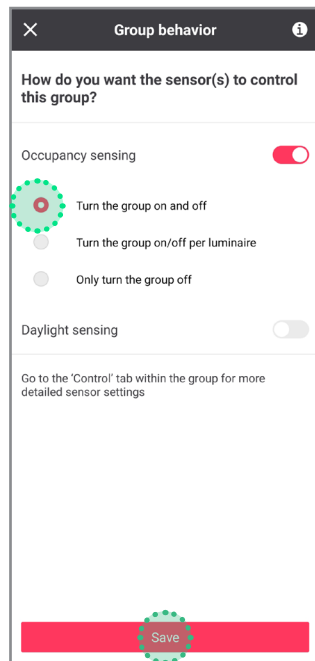
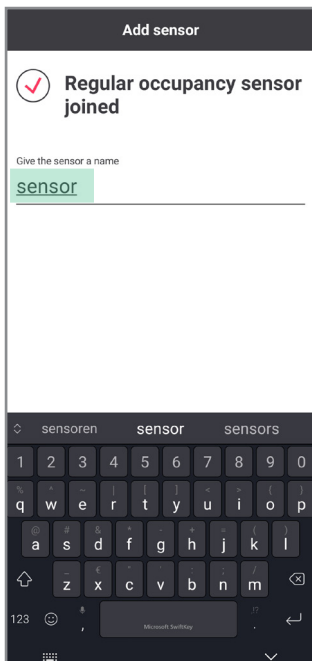
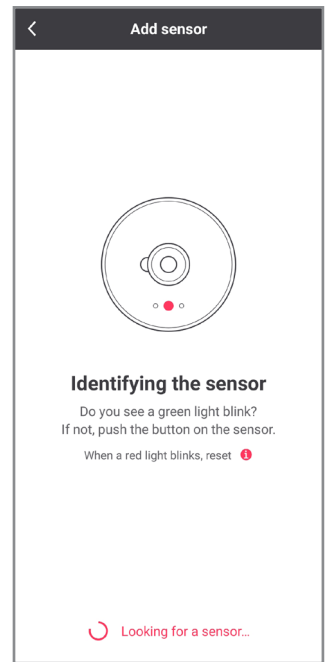
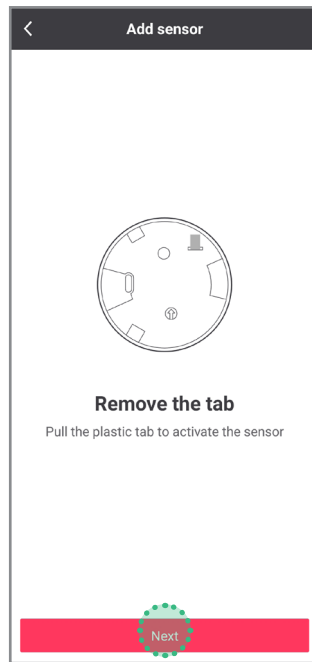
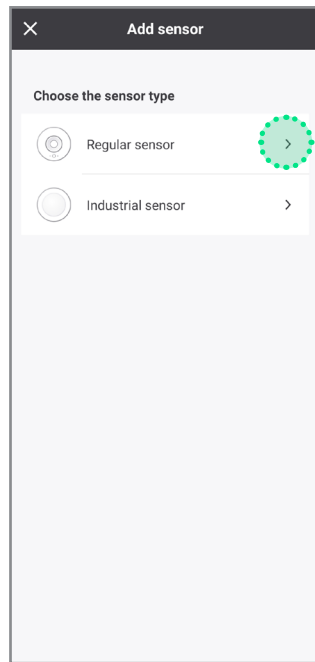

6

Configure the system without motion sensors

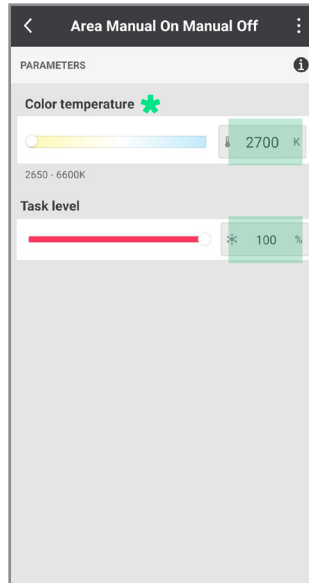
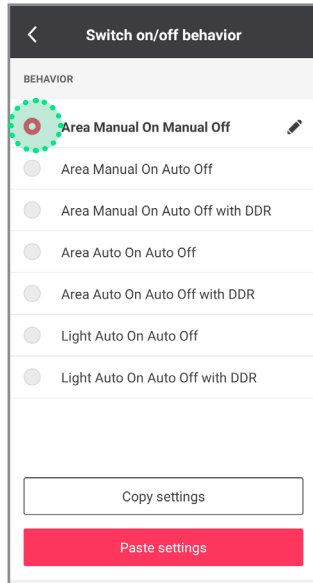
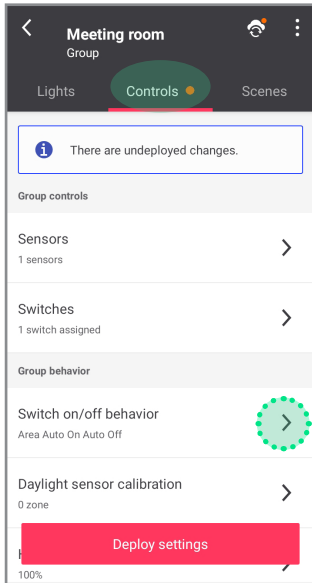

Follow below steps:

- 1 Set CCT to 2700 K
 - ▶ Press “enter” or “OK”
- 2 Set Task level to 100%
 - ▶ Press “enter” or “OK”

* If color temperature slider is missing, follow the procedure indicated in the paragraph B in the Problem Solving chapter.

! If you are not using any user interface, skip to step 9.

7

Add one or more user interfaces

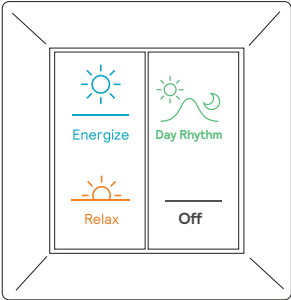

When more than one switch is used, all switches will behave in the same way.

Tab **Controls**: click on **Switches**

Click **Show switch in the group**

Select **4 button switch**

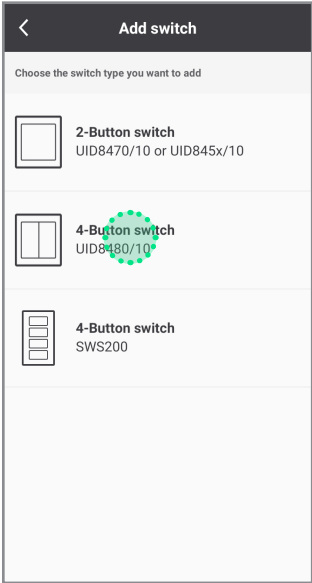
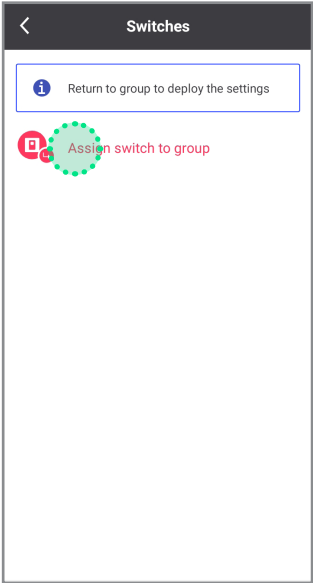
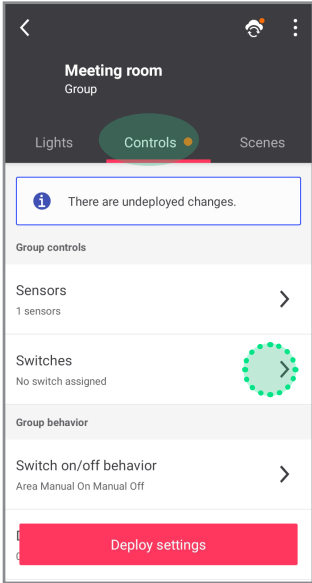

Identify the switch following the instructions

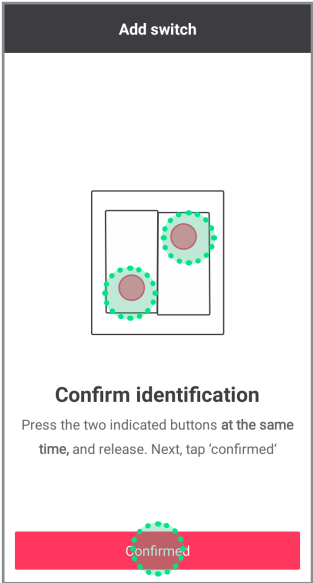
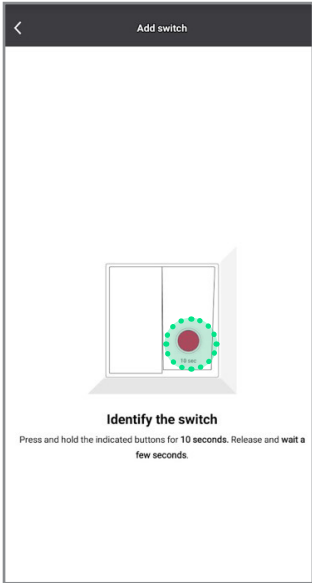

Test if the switch is added by clicking ON/OFF button

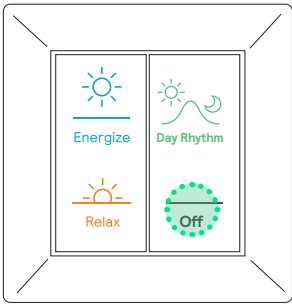

Lights turned off? If yes 

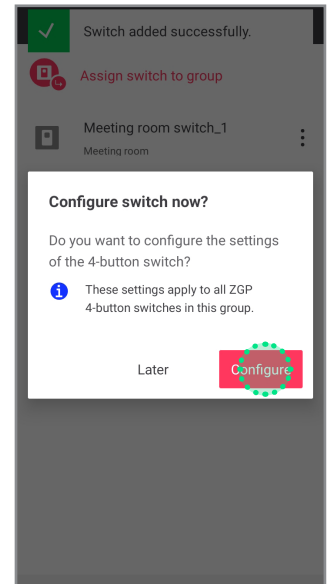
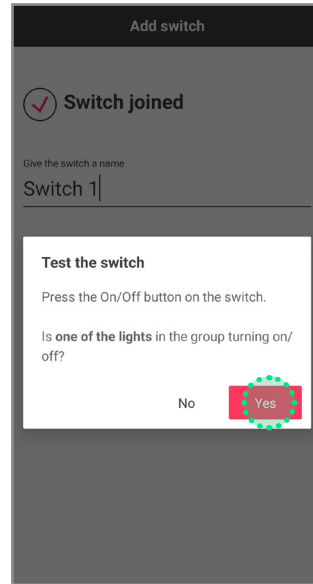

In case luminaires in the group do not turn off, follow below steps

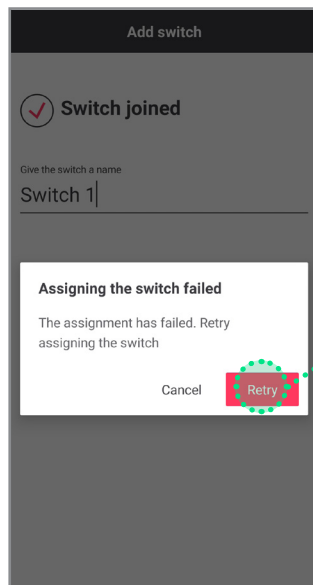

Retry will restart the add switch flow from the beginning.



If the same error occurs again, follow the procedure indicated in the paragraph A in the Problem Solving chapter.

8

Configure the four button switch



Configure the TOP LEFT button as the ENERGIZE scene

WARNING!
If you are missing the tunable white slider go to D section (page 20) in the "Problem solving" chapter, at the end of this document.

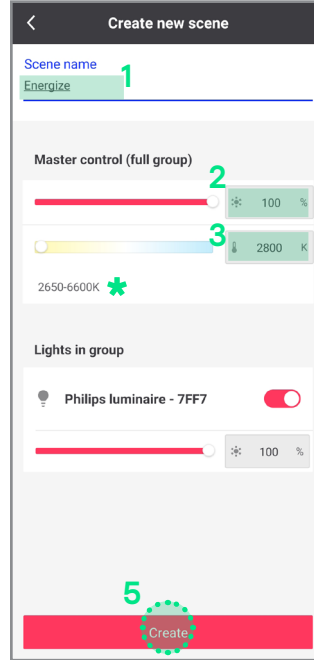
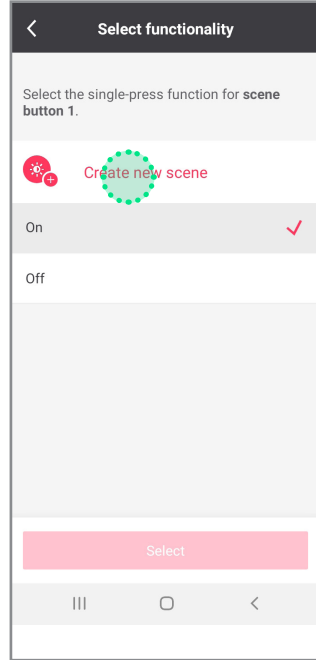
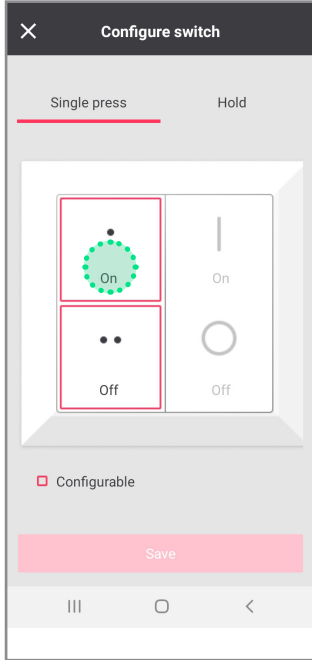

Follow below steps:

- 1 Type the name of the scene
- 2 Set brightness to 100%
▶ Press "enter" or "OK"
- 3 Set CCT to 2800 K
▶ Press "enter" or "OK"
- 4 Wait 5 seconds
- 5 Click on "Create"

Configure the BOTTOM LEFT button as the RELAX scene

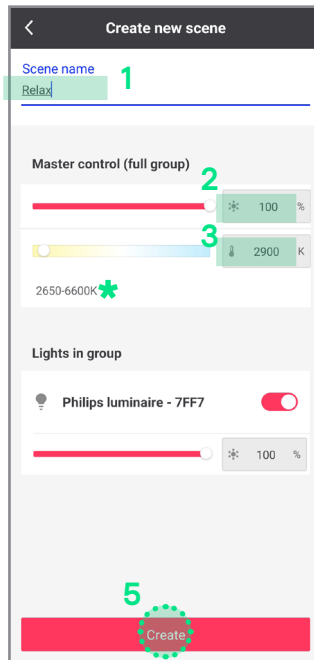
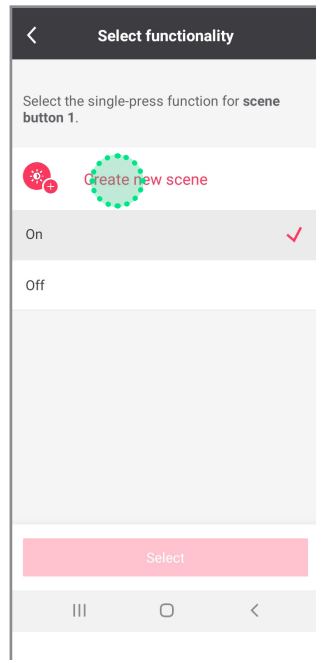
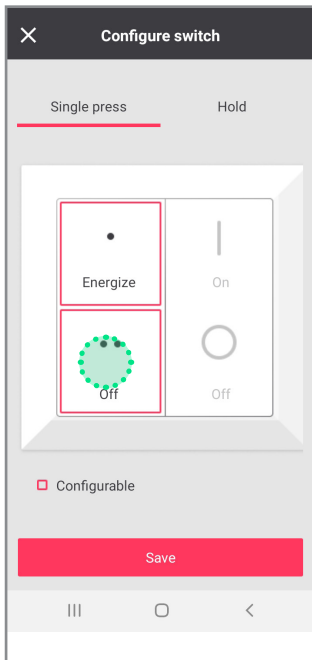

Follow below steps:

- 1 Type the name of the scene
- 2 Set brightness to 100%
▶ Press "enter" or "OK"
- 3 Set CCT to 2900 K
▶ Press "enter" or "OK"
- 4 Wait 5 seconds
- 5 Click on "Create"

* If color temperature slider is missing, follow the procedure indicated in the paragraph B in the Problem Solving chapter.

Deploy

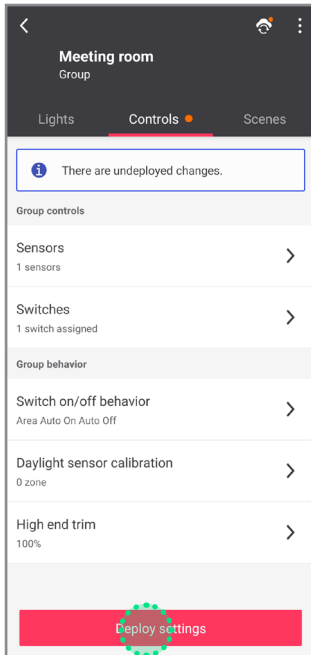

Unlock

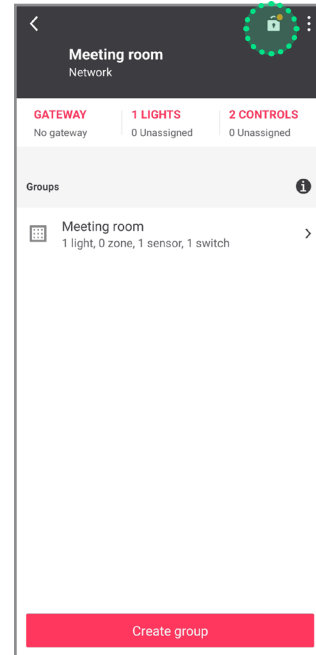
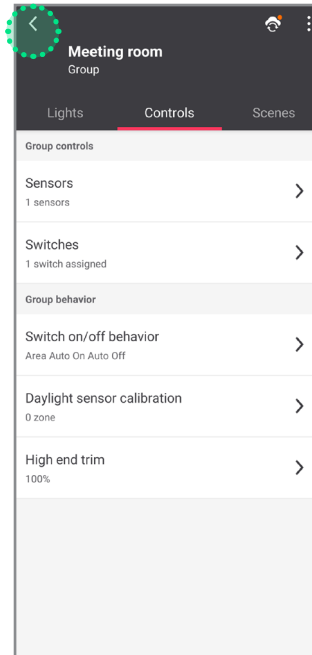

Additional scenes (optional)

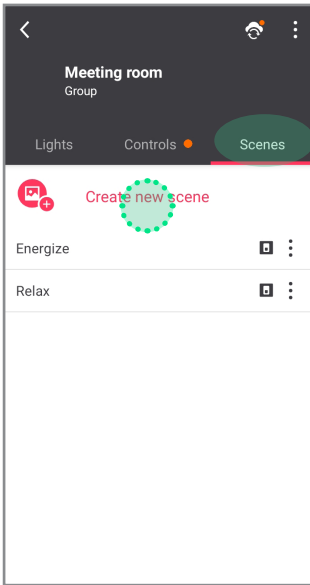

! NOT REQUIRED if using only the user interface.

DAY RHYTHM scene

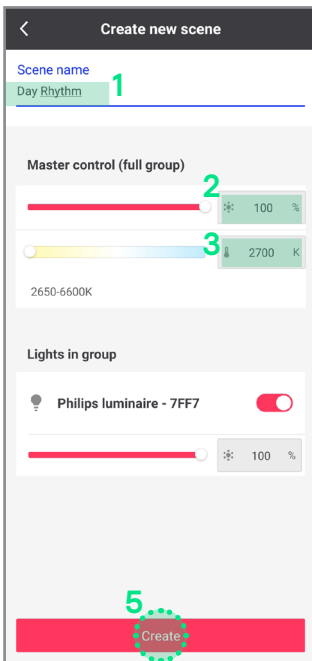

Follow below steps:

- 1 Type the name of the scene
- 2 Set brightness to 100%
▶ Press "enter" or "OK"
- 3 Set CCT to 2700 K
▶ Press "enter" or "OK"
- 4 Wait 5 seconds
- 5 Click on "Create"

PRESENT scene

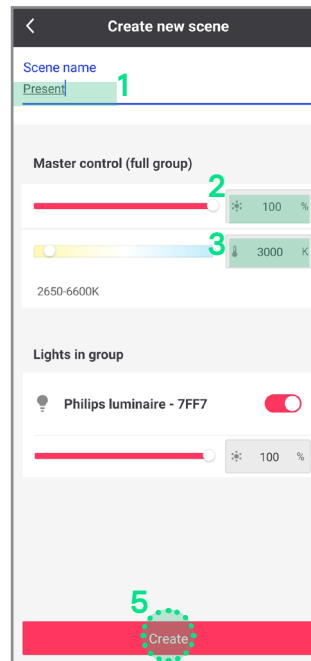

Follow below steps:

- 1 Type the name of the scene
- 2 Set brightness to 100%
▶ Press "enter" or "OK"
- 3 Set CCT to 3000 K
▶ Press "enter" or "OK"
- 4 Wait 5 seconds
- 5 Click on "Create"

DEMO MODE

It is possible to program a scene that runs in cycle a faster mode of the dynamic scenes. Suitable for demo purposes controlled through the commissioning app.

DEMO DAY RHYTHM scene



Day Rhythm

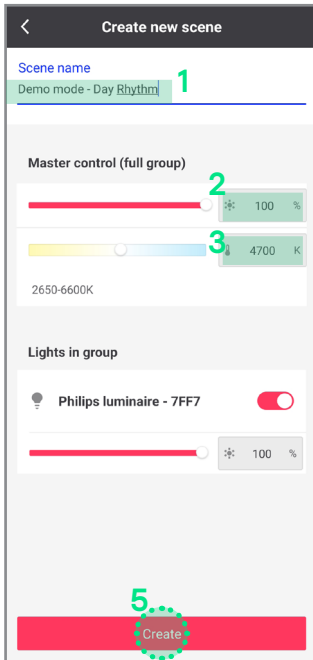

Follow below steps:

- 1 Type the name of the scene
- 2 Set brightness to 100%
▶ Press “enter” or “OK”
- 3 Set CCT to 4700 K
▶ Press “enter” or “OK”
- 4 Wait 5 seconds
- 5 Click on “Create”

DEMO ENERGIZE scene



Energize

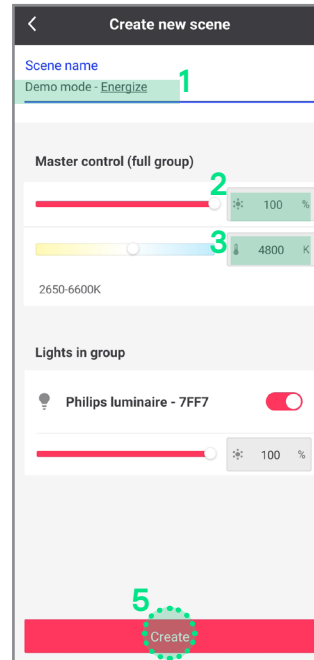

Follow below steps:

- 1 Type the name of the scene
- 2 Set brightness to 100%
▶ Press “enter” or “OK”
- 3 Set CCT to 4800 K
▶ Press “enter” or “OK”
- 4 Wait 5 seconds
- 5 Click on “Create”

DEMO RELAX scene



Relax

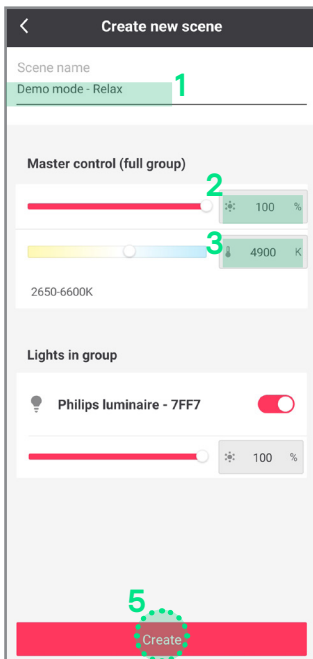

Follow below steps:

- 1 Type the name of the scene
- 2 Set brightness to 100%
▶ Press “enter” or “OK”
- 3 Set CCT to 4800 K
▶ Press “enter” or “OK”
- 4 Wait 5 seconds
- 5 Click on “Create”

Problem solving

A Cannot add a switch to a group (PRF)

If it is impossible to make the luminaires react to the switch remove the switch from the configurator and restart the process from the beginning.

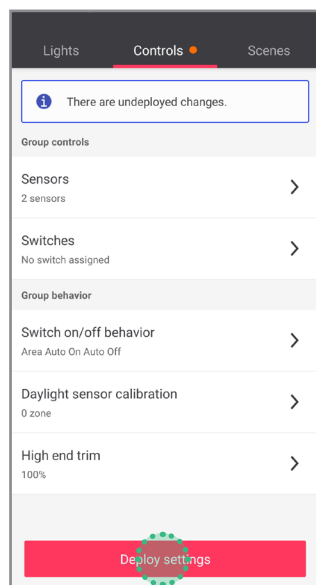
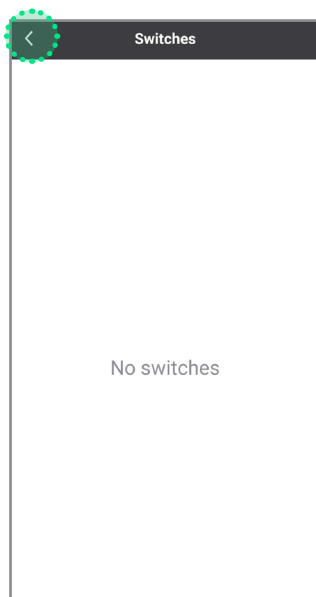
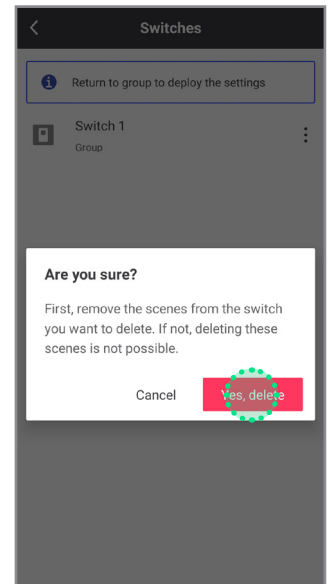
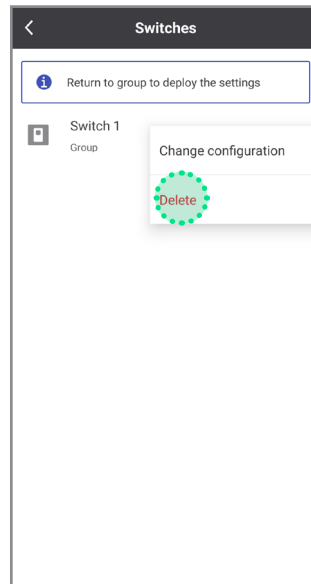
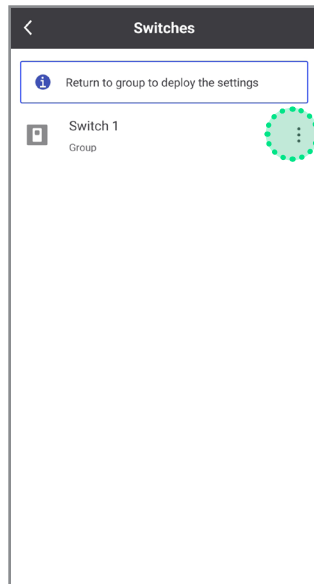
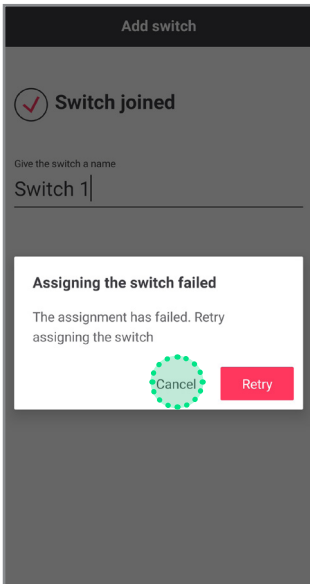

Go back to commissioning, step 7.

B

What to do if the color temperature slider is missing

Under certain circumstances it is possible for the NatureConnect link to not be detected as a tunable white device. To fix this it is necessary to remove it from the system and add it again.

Remove NatureConnect link

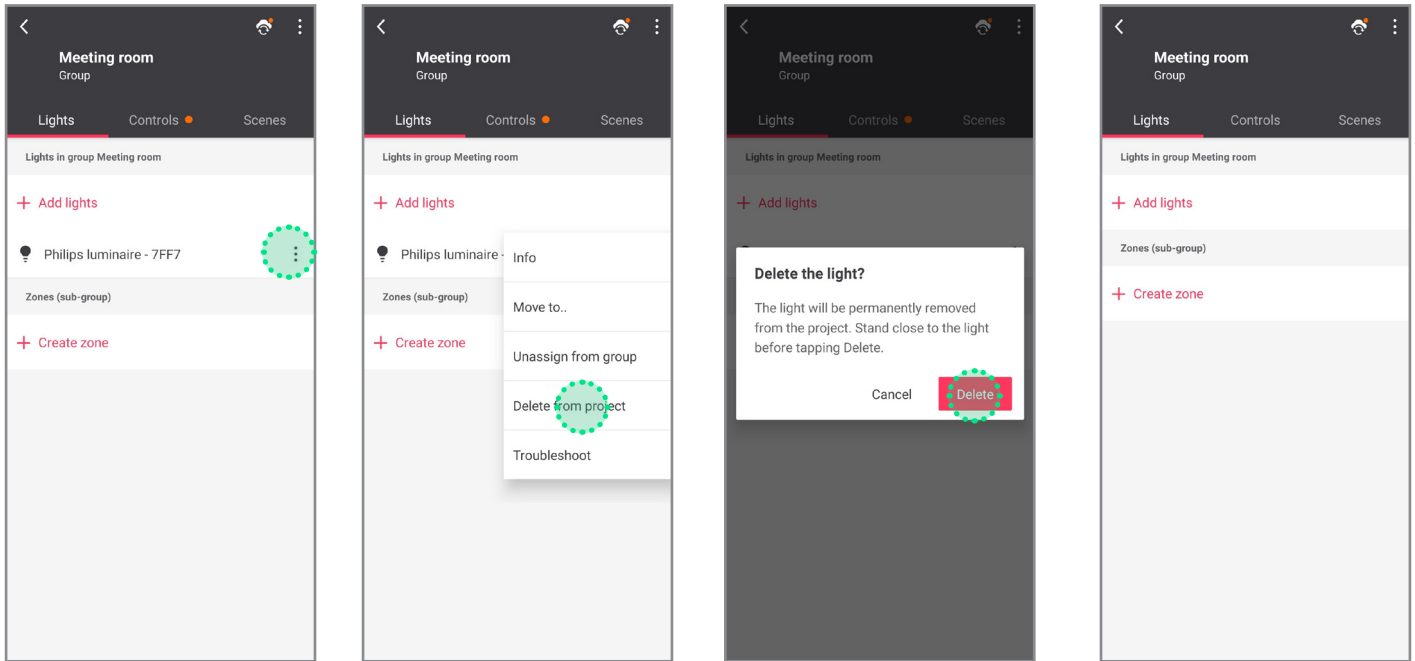

Reboot NatureConnect link

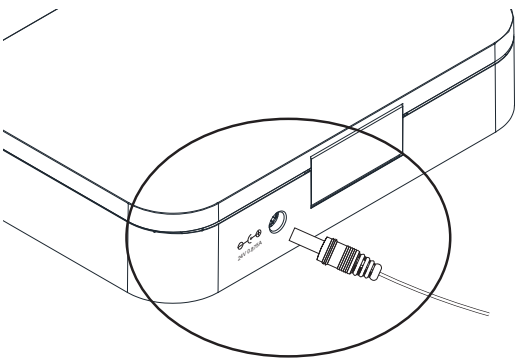

- 1 Remove power for 10 seconds.
 - 2 Wait 5 minutes until the NC link has fully started before continuing.*
 - 3 Go back to step 4: "Find and assign the NatureConnect link connected with a SNS210"
- * During the NC link boot process, the SNS210 loses power temporarily. If this happens during the commissioning process, you might have to reset the SNS210.

C What to do when system responds incorrectly to the inputs from the switch

It can happen that the scene is saved incorrectly and that the system does not respond or triggers the wrong light experience when pressing a scene button on the switch.

This typically happens when you do not wait for 5 seconds between changing the color temperature and pressing the create button.

Change the color temperature of the Energize scene to a wrong value on purpose (eg. 6600K) and save.

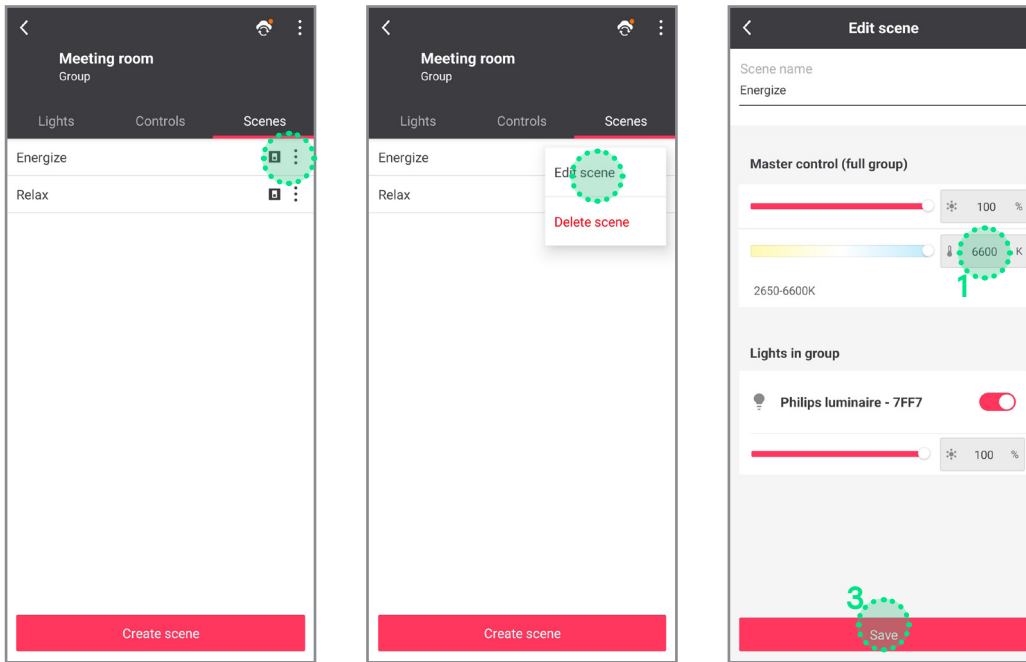

2 Wait 5 seconds, after setting CCT, before clicking on “Save”

Change the color temperature of the Energize scene back to correct value (2800K) and save.

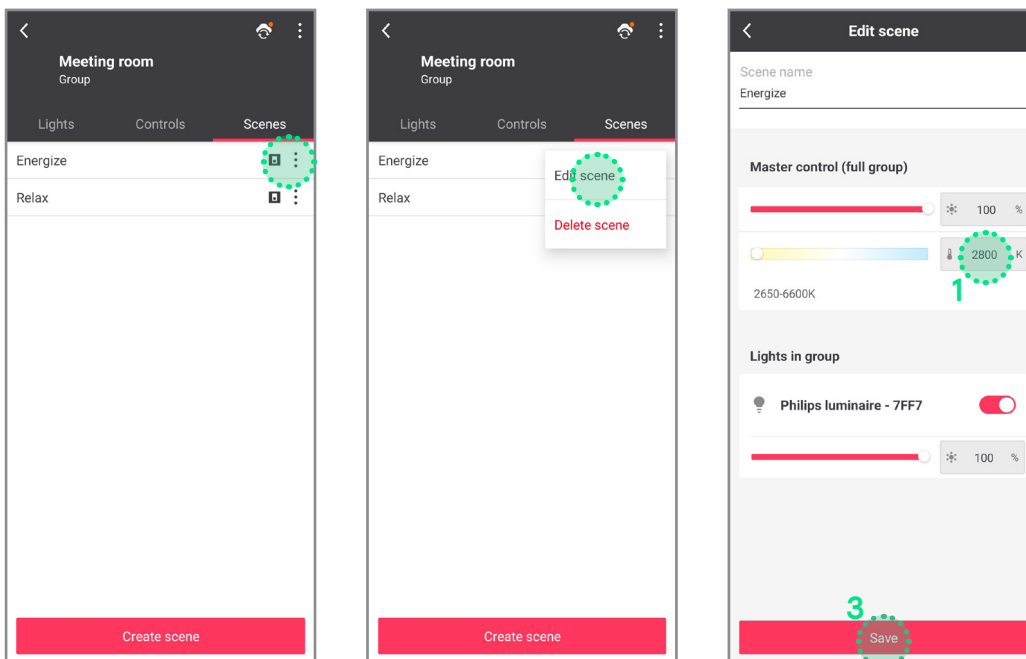

2 Wait 5 seconds, after setting CCT, before clicking on “Save”

Repeat the same steps for Relax scene

D What to do when color temperature slider is missing during scene creation.

When scene creation does not work correctly when adding a switch, please use the regular scene menu to create the scene.

Go back to **Control** panel and then go to **Scenes** panel.

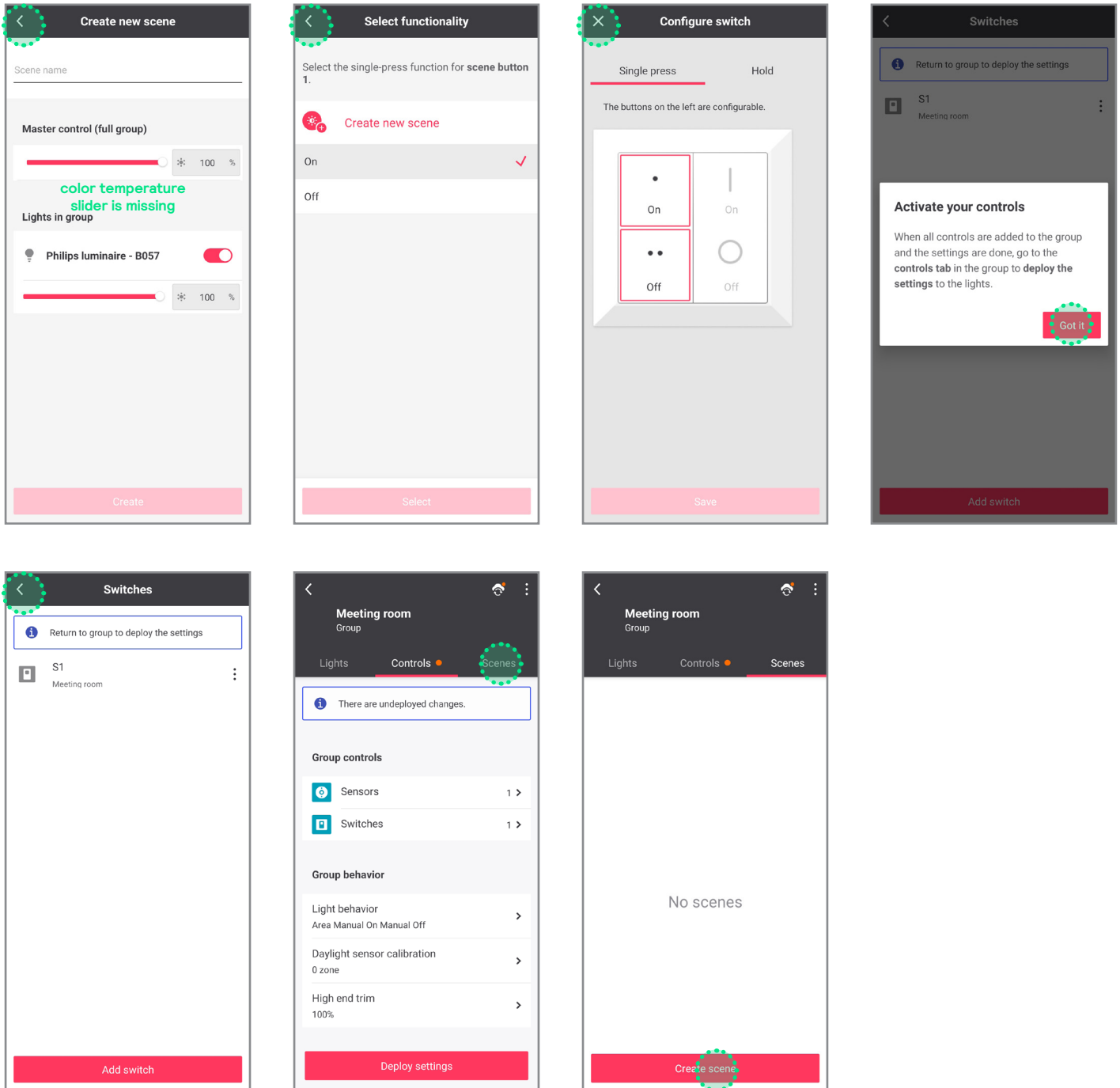

Create scenes as described on page 13. After go back to **Controls** panel.

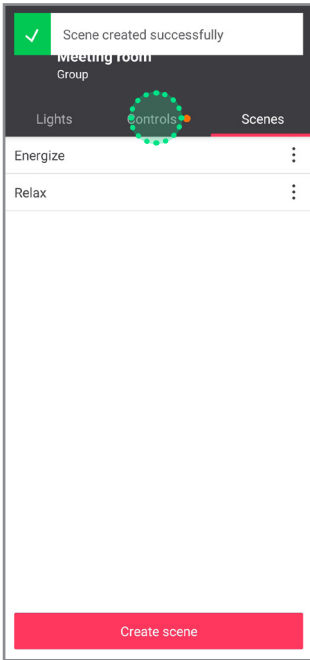

Assign scenes to the buttons of the switch.

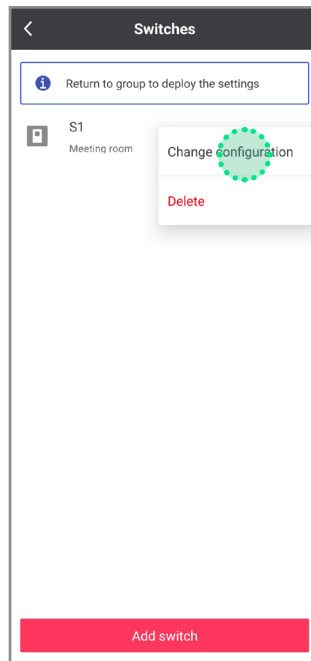
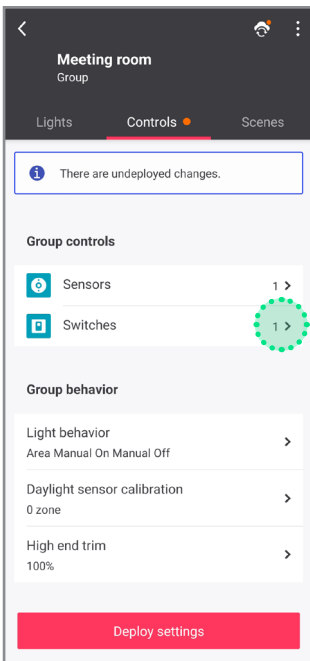

Upper left button for Energize

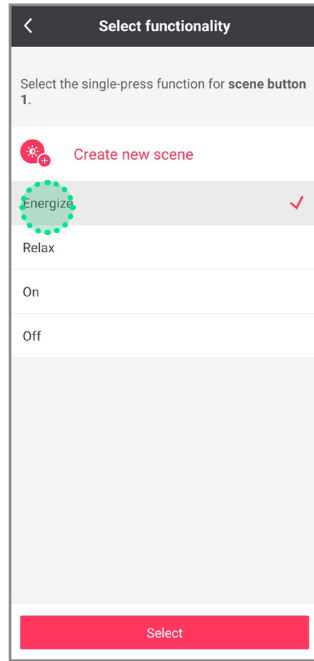
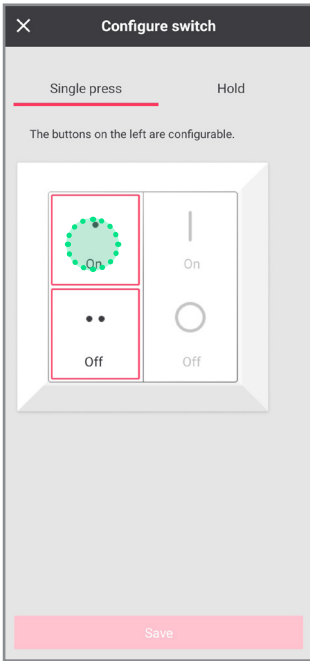

Lower left button for Relax

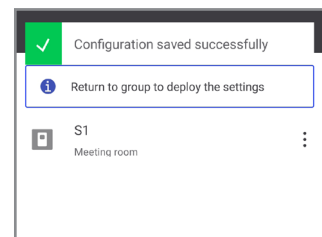
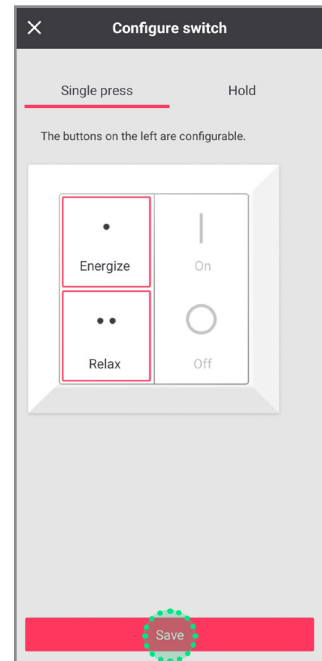
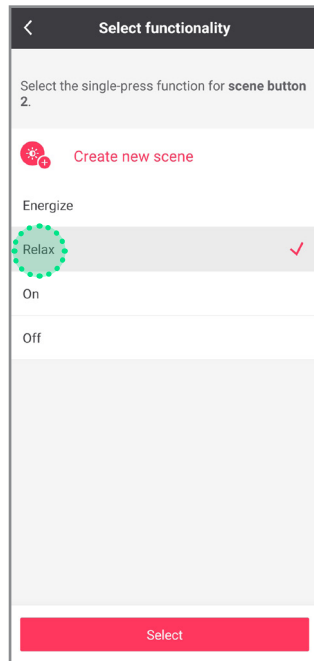
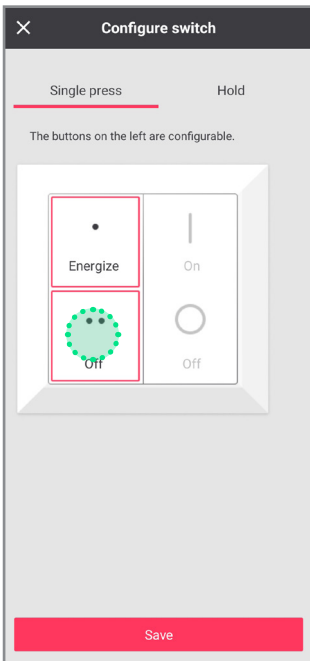



© 2024 Signify Holding. All rights reserved. The information provided herein is subject to change, without notice. Signify does not give any representation or warranty as to the accuracy or completeness of the information included herein and shall not be liable for any action in reliance thereon. The information presented in this document is not intended as any commercial offer and does not form part of any quotation or contract, unless otherwise agreed by Signify.

All trademarks are owned by Signify Holding or their respective owners