

PHILIPS

Arbour Ultra Efficient
9290032660

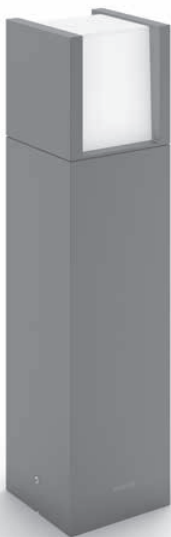

User manual
Benutzerhandbuch
Notice d'emploi
Manual de usuario
Manual do usuário
Manuale d'uso
Gebruiksaanwijzing

Incl.

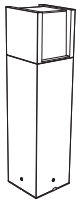

Excl.

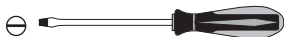
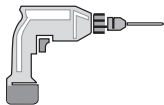

IP44

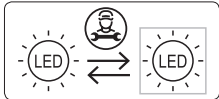

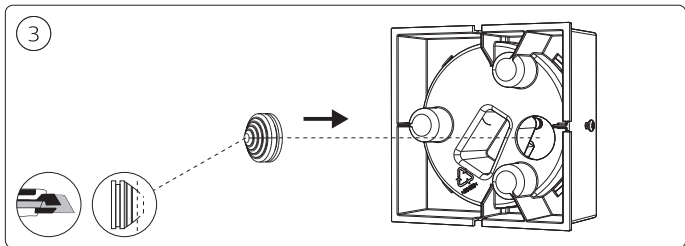
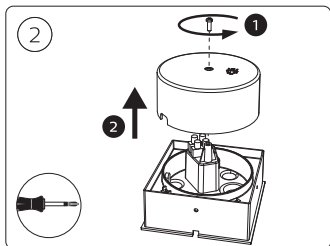
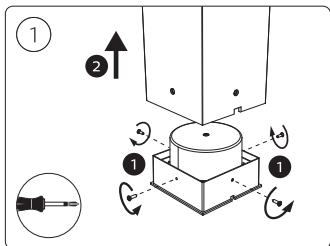
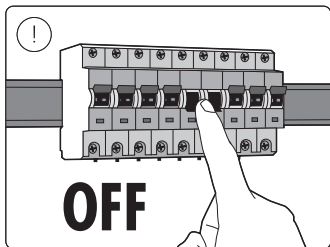
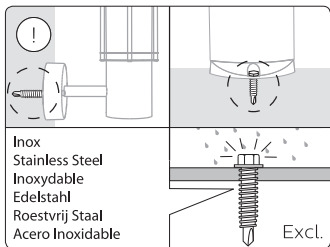

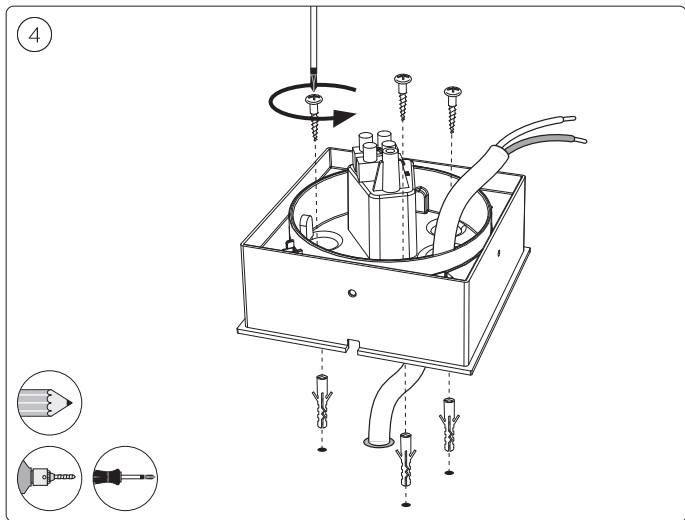
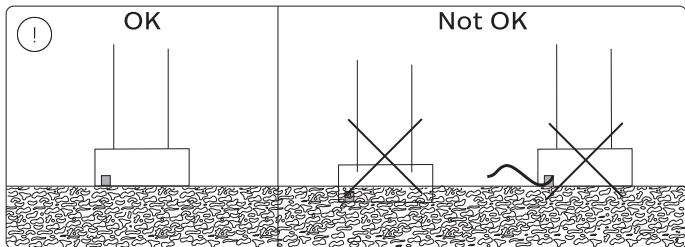

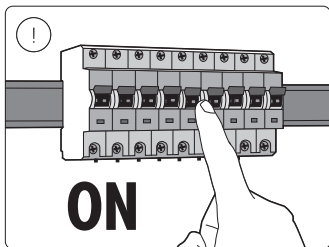
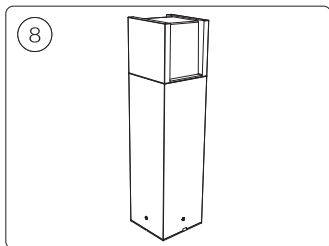
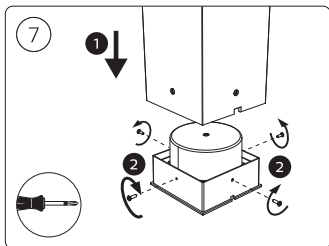
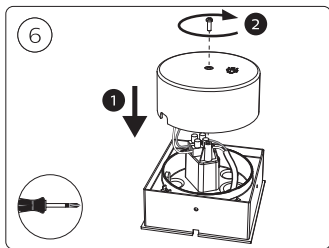
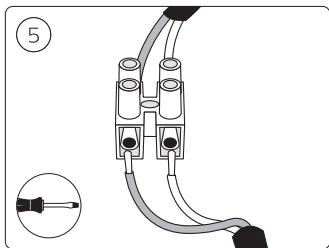



Signify Commercial UK Limited
Unit 3, Guildford Business Park,
Guildford, Surrey, GU2 8XG, UK

Signify
I.B.R.S. / C.C.R.I. Numéro 10461
5600 VB Eindhoven,
the Netherlands
☎00800-74454775

Philips and the Philips Shield Emblem are registered trademarks
of Koninklijke Philips N.V. and are used under license

3241 659 63141
www.philips.com/lighting

© 2022 Signify Holding

The Signify logo, consisting of a stylized 'S' inside a circle followed by the word "ignify" in a lowercase, sans-serif font.