

PHILIPS

hue personal
wireless
lighting

Enrave XL



HUE serial number



User manual
사용 설명서

Enrave XL

Incl.



1 x CR2032 +

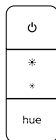

Excl.

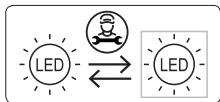
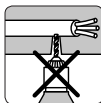
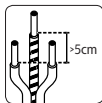
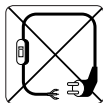
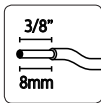
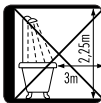
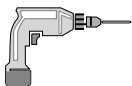

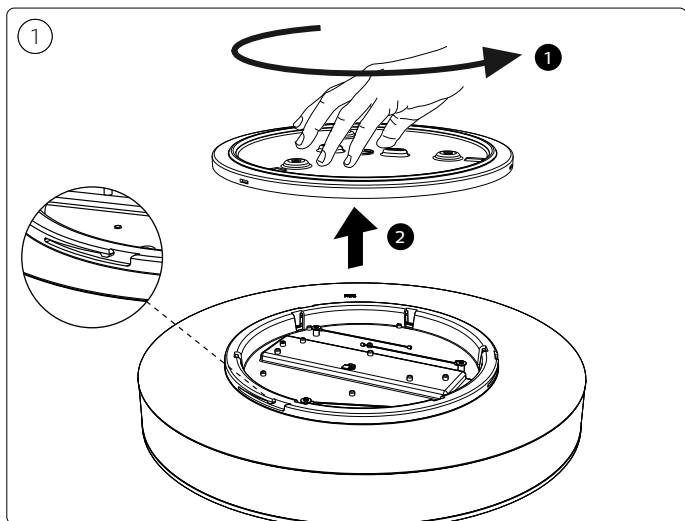
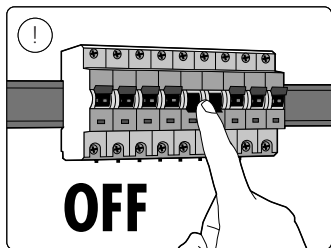

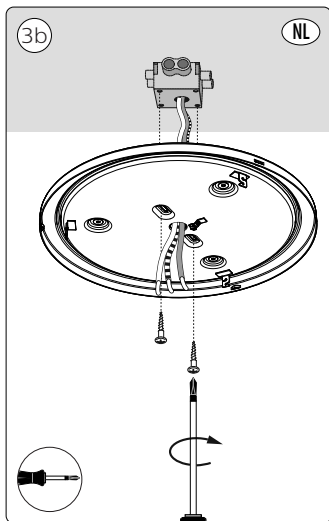
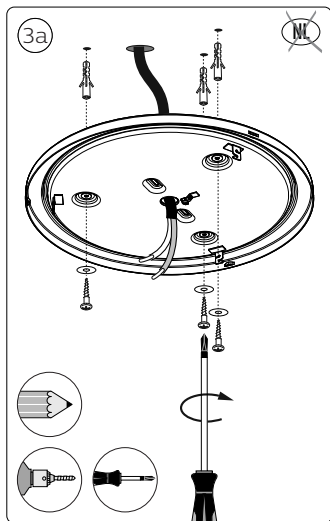
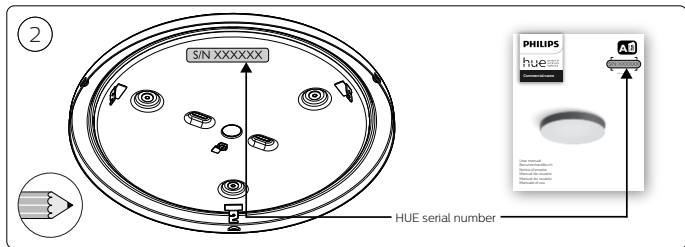

4

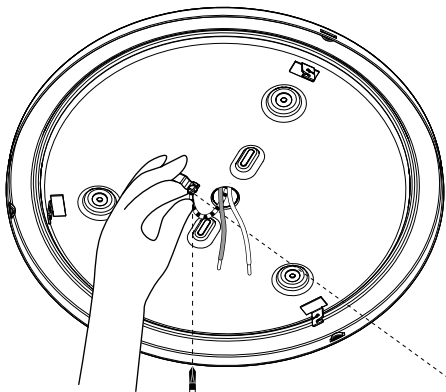

5

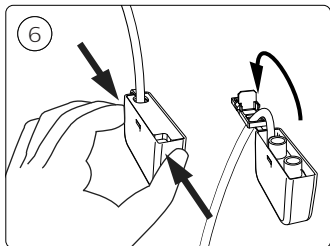
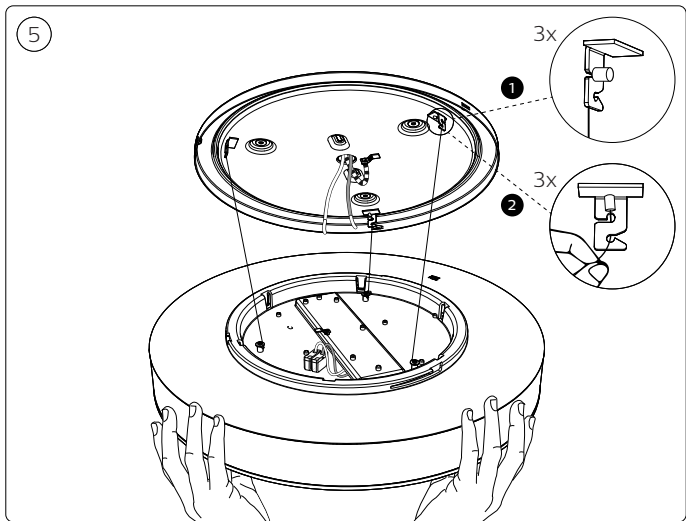

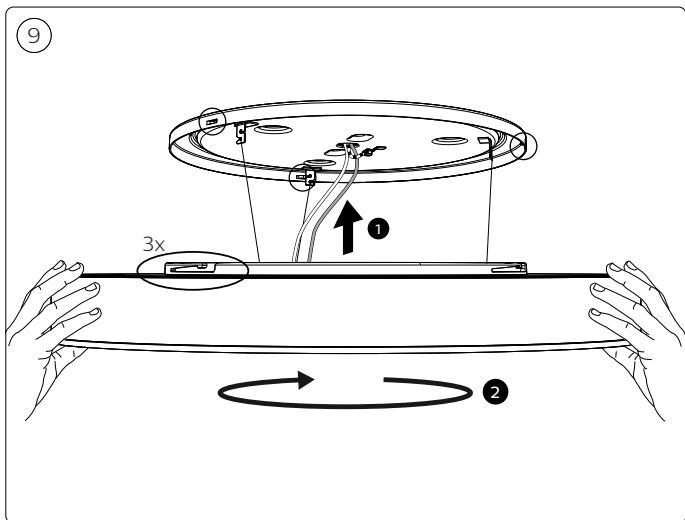
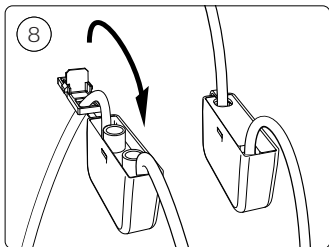
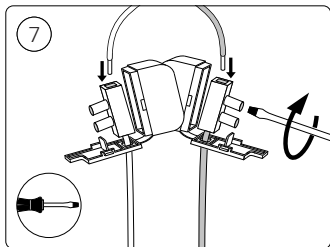

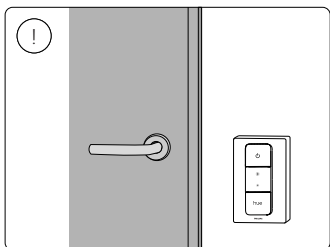
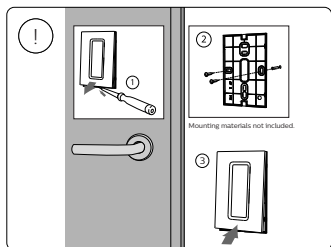
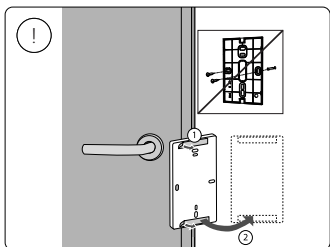
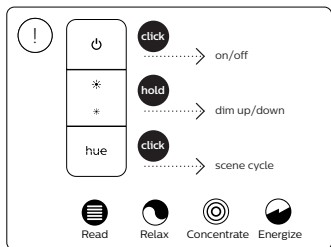
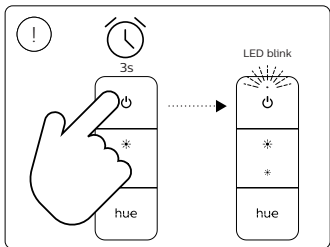
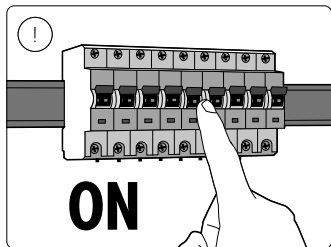

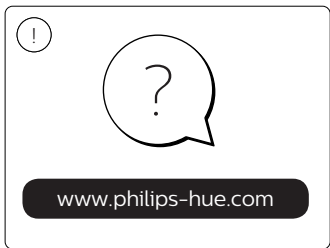
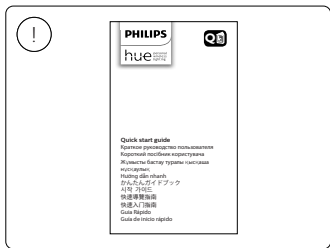
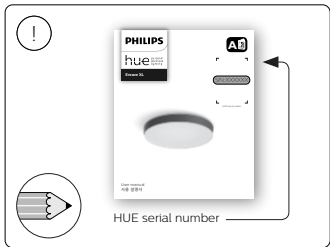
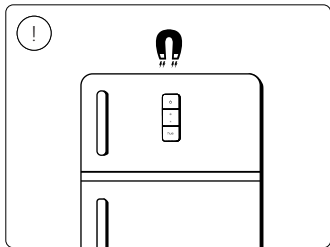



Signify
I.B.R.S. / C.C.R.I. Numéro 10461
5600 VB Eindhoven,
the Netherlands
☎00800-74454775

© 2022 Signify Holding
All rights reserved

www.philips-hue.com

3241 659 60051
Last update: 03/2022