

**PHILIPS**

hue personal  
wireless  
lighting

Enrave L



HUE serial number



User manual  
使用说明书

# Engrave L

Incl.



1 x CR2032 +

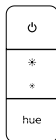

Excl.

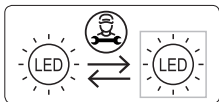
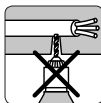
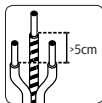
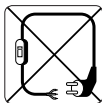
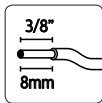
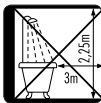
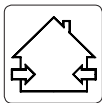
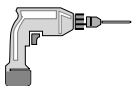

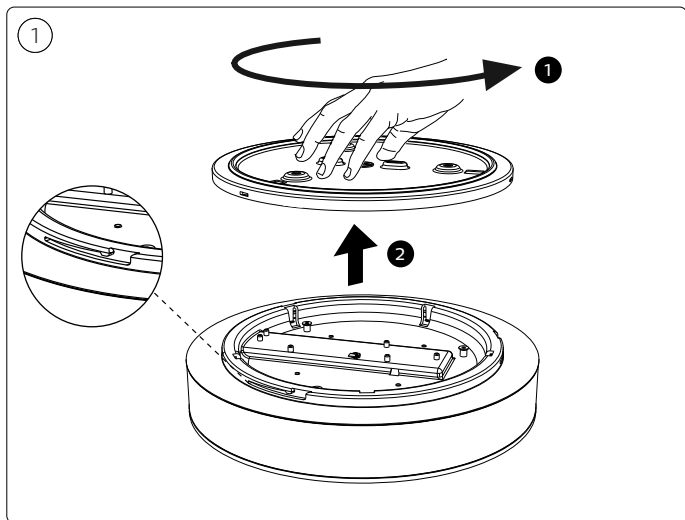
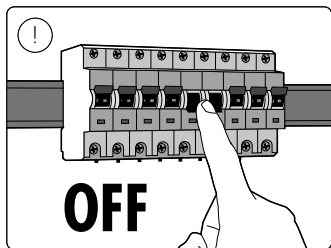

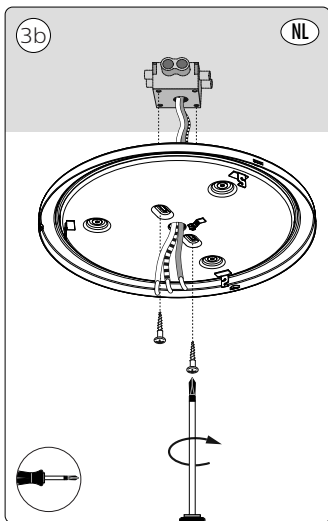
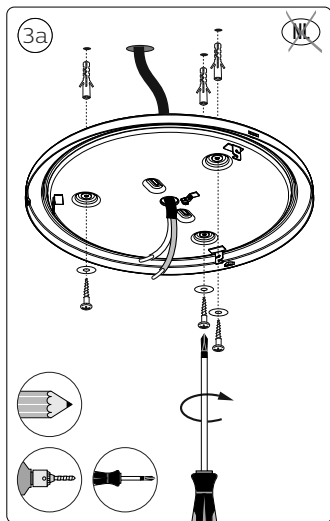
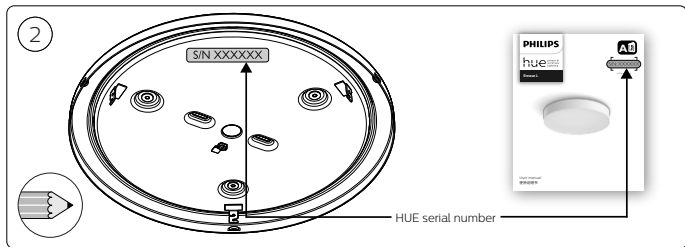

4

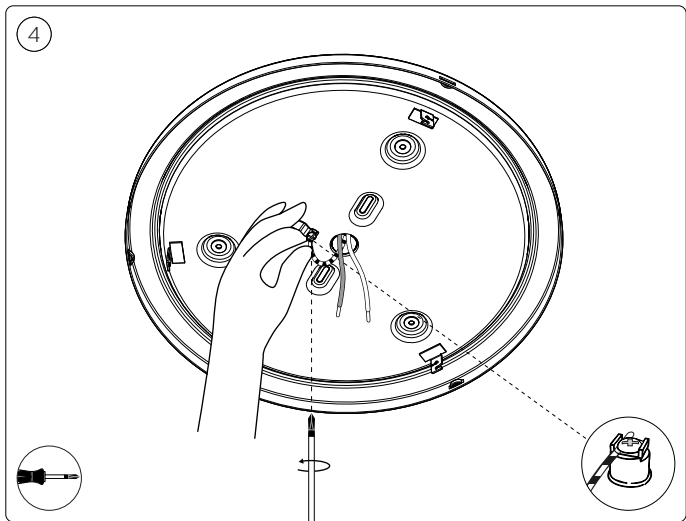

5

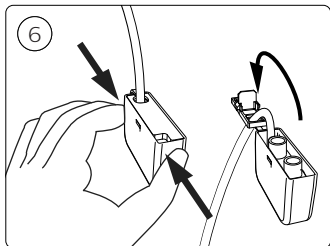
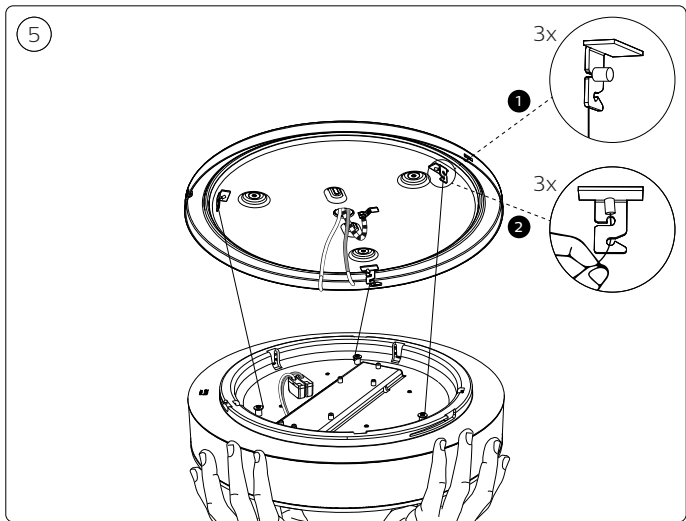

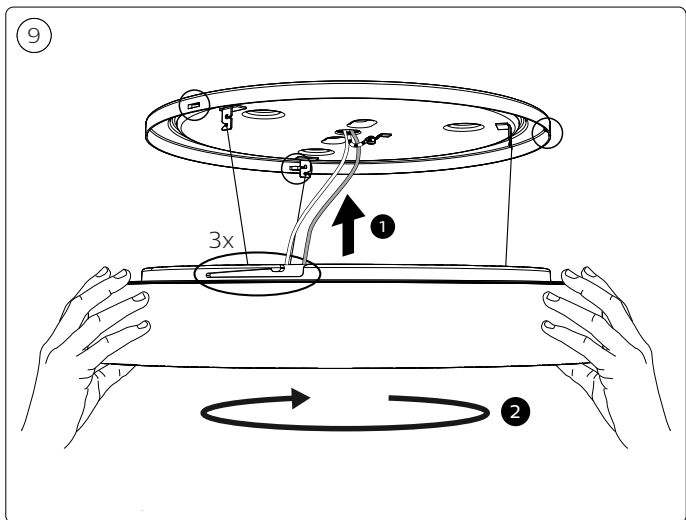
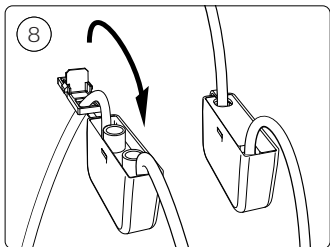
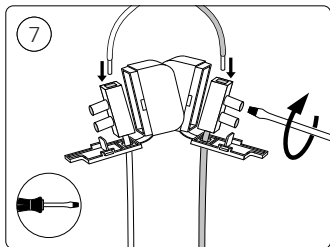

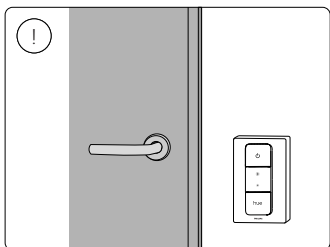
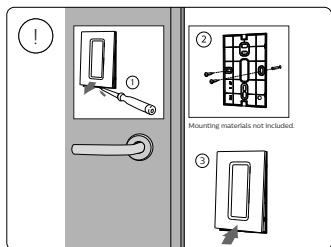
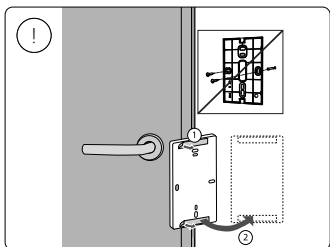
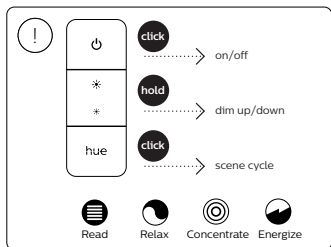
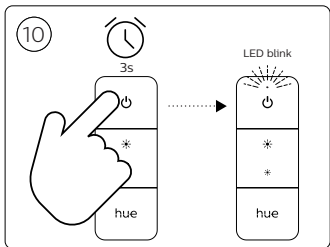
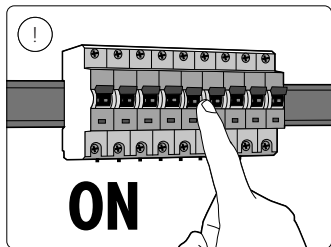



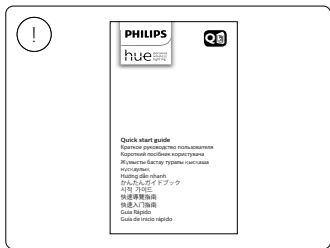
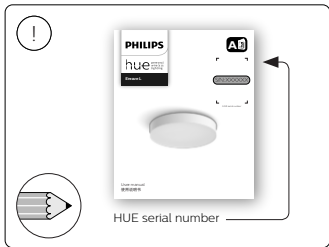
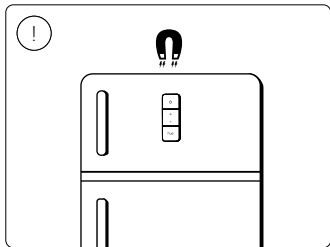







Signify  
I.B.R.S. / C.C.R.I. Numéro 10461  
5600 VB Eindhoven,  
the Netherlands  
☎00800-74454775

© 2022 Signify Holding  
All rights reserved

[www.philips-hue.com](http://www.philips-hue.com)

3241 659 60031  
Last update: 03/2022