

## Dismantling Recommendation on Disposal at End of Life

### Composition Explanation

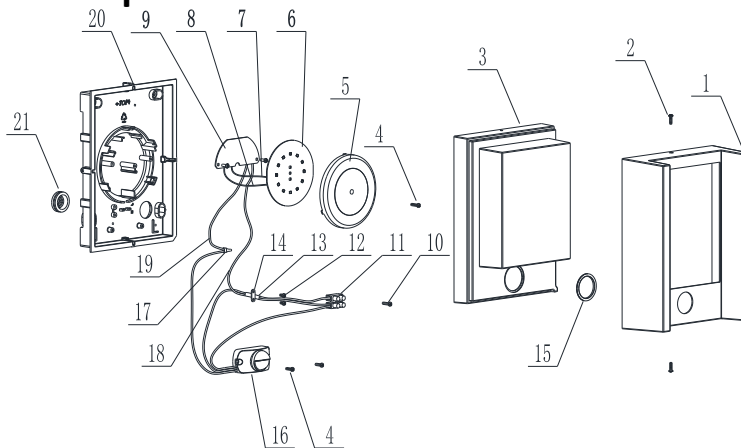

No.	Components	Specifications	Unit	Quantity
1	Light body	AL	PCS	1
2	BT3*10 screw	SS	PCS	2
3	Diffuser	PP	PCS	1
4	ST2.9*10 screw	Zinc coated	PCS	1
5	Inner cover	PC	PCS	1
6	L2		PCS	1
7	VDE red wire	H05S-K,1*0.5mm <sup>2</sup>	PCS	1
8	VDE black wire	H05S-K,1*0.5mm <sup>2</sup>	PCS	1
9	Driver		PCS	1
10	ST2.9*14 screw	Zinc coated	PCS	1
11	Terminal block	PA10	PCS	1
12	BT2.9*6 screw	Zinc coated	PCS	4
13	Ø5 heat shrinkable tube		PCS	1
14	Strain relief	PA6	PCS	1
15	Plastic ring	ABS	PCS	1
16	M3*6 screw	Zinc coated	PCS	2
17	Sensor	\	PCS	1
18	BT3*5 screw	Zinc coated	PCS	2
19	Bracket	Metal	PCS	1
20	Gromet	TPE	PCS	1
21	Closed end connector		PCS	1
22	VDE brown wire	H05S-K 0.75mm <sup>2</sup>	PCS	1
23	VDE blue wire	H05S-K 0.75mm <sup>2</sup>	PCS	1
24	Wall plate	PC	PCS	1
25	O ring	rubber	PCS	1

## Dismantling Recommendation on Disposal at End of Life

### Dismantling

- Type: Without permanent damage

### Recommendation on Disposal

- Plastic part: Reuse and Recycling
- Electrical part: Incineration and disposal
- Metal part: Recycling

### Light source dismantling process

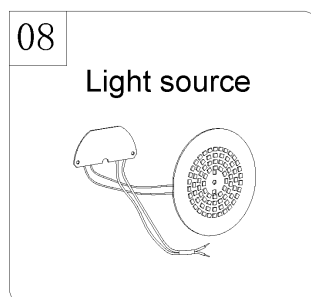
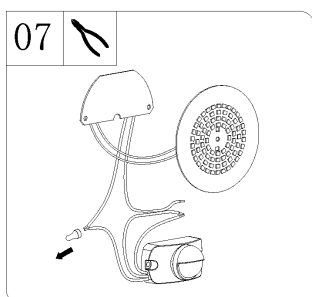
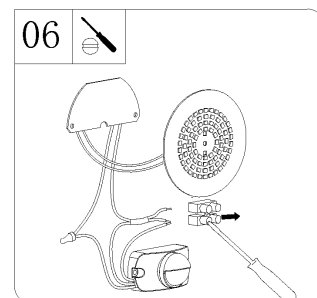
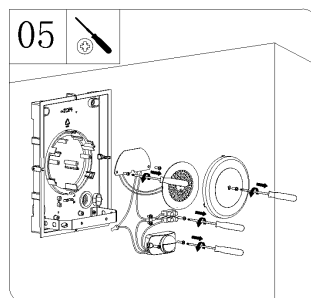
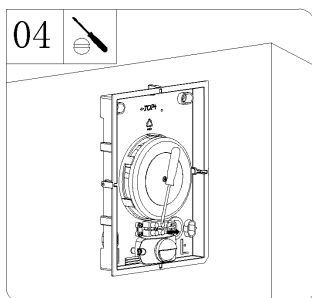
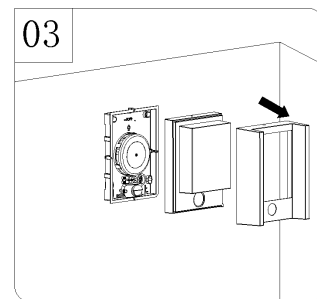
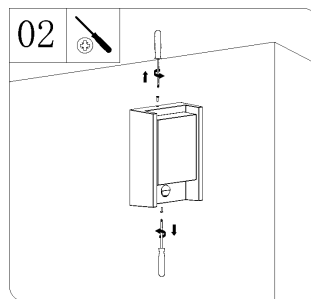
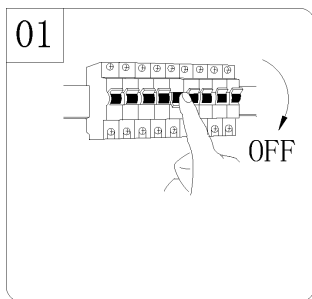

## Dismantling Recommendation on Disposal at End of Life

New Light Source Assembly Instruction:

