

Dismantling Recommendation on Disposal at End of Life

Composition Explanation

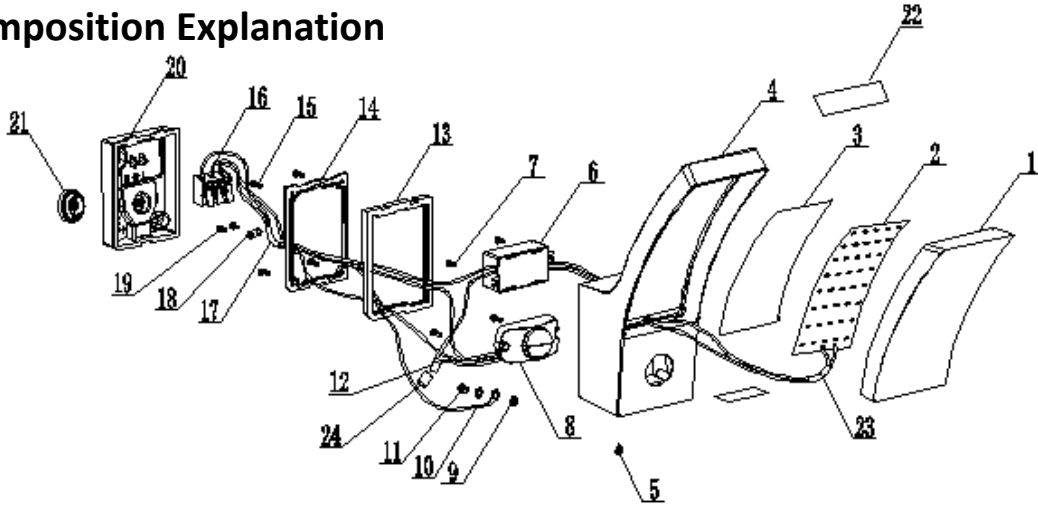

No.	Components	Specifications	Unit	Quantity
1	Diffuser	PC	PCS	1
2	L2		PCS	1
3	sticker	rubber	PCS	1
4	Body	AL	PCS	1
5	M5*10 screw	SS	PCS	1
6	Driver		PCS	1
7	M3*5 screw	Zinc coated	PCS	2
8	Sensor		PCS	1
9	Φ4 teeth washer	Zinc coated	PCS	2
10	Earthing wire		PCS	1
11	M4*8 screw	Zinc coated	PCS	1
12	Closed end connector		PCS	1
13	Gasket	Rubber	PCS	1
14	Cover	ABS	PCS	1
15	M3*8 screw	Zinc coated	PCS	4
16	Terminal block	PA10	PCS	1
17	Ø5 heat shrinkable tube		M	0.03
18	Strain relief	PA6	PCS	1
19	BT2.9*6 screw	Zinc coated	PCS	2
20	Wall plate	PA6	PCS	1
21	gromet	Rubber	PCS	1
22	Reflector sheet		PCS	2
23	Φ3 heat shrinkable tube	Φ3	M	0.03
24	Φ8 heat shrinkable tube	Φ8	M	0.04

Dismantling Recommendation on Disposal at End of Life

Dismantling

- Type: Without permanent damage

Recommendation on Disposal

- Plastic part: Reuse and Recycling
- Electrical part: Incineration and disposal
- Metal part: Recycling

Light source dismantling process

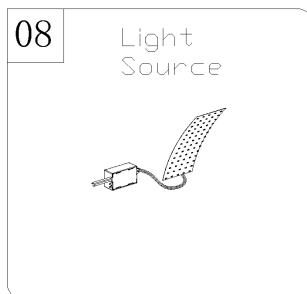
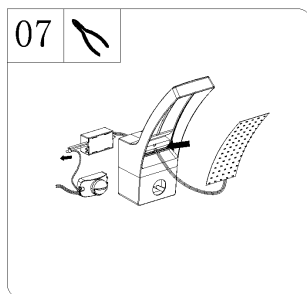
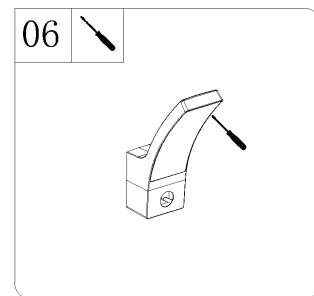
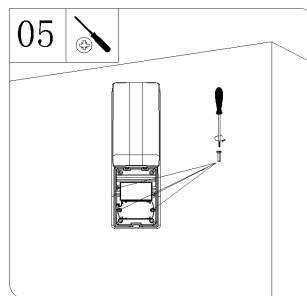
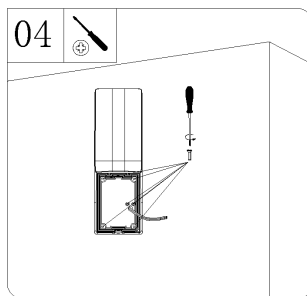
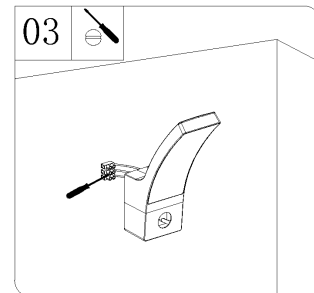
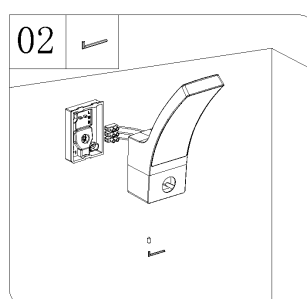
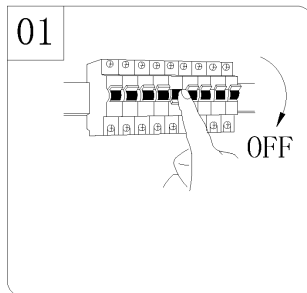

Dismantling Recommendation on Disposal at End of Life

New Light Source Assembly Instruction:

