



Classic LEDspotLV

LEDClassic 5-50W MR16 840 60D 6pack

LEDspotLV Classic offers an archetypal halogen-like design while delivering the benefits of LED technology, saving around 85% on energy consumption, minimizing maintenance cost, and much more besides. It is compatible with most existing fixtures with a GU 5.3 holder and is designed as a retrofit replacement for halogen or incandescent spots.

Product data

General Information		Power Consumption	
Cap-Base	GU5.3	Power Consumption	5 W
Nominal lifetime	15,000 h	Lamp Current (Nom)	580 mA
Switching Cycle	50,000	Wattage Equivalent	50 W
Rated Lifetime (Hours)	15,000 h	Starting Time (Nom)	0.5 s
Lighting Technology	LED	Warm-up time to 60% light	0.5 s
		Power Factor (Fraction)	0.6
		Voltage (Nom)	ac electronic 12 V
Light Technical		Temperature	
Color Code	840 [CCT of 4000K]	Ambient temperature range	-20 to +40 °C
Beam Angle (Nom)	60 degree(s)	T-Case Maximum (Nom)	65 °C
Luminous Flux	410 lm		
Luminous Intensity (Nom)	420 cd	Controls and Dimming	
Color Designation	Cool White (CW)	Dimmable	No
Luminous Efficacy (rated) (Nom)	82 lm/W		
Correlated Color Temperature (Nom)	4000 K	Mechanical and Housing	
Color Consistency	<6	Bulb Finish	Clear
Color rendering index (CRI)	80	Bulb Material	Glass
LLMF At End Of Nominal Lifetime (Nom)	70 %	Bulb Shape	MR16
Operating and Electrical		Approval and Application	
Line Frequency	- Hz	Suitable For Accent Lighting	Yes
Input Frequency	- Hz		

Classic LEDspotLV

Energy Consumption kWh/1000 h	6 kWh
EU RoHS compliant	Yes
EyeComfort	Yes
LED Innovations	EyeComfort

Product Data

Order product name	LEDClassic 5-50W MR16 840 60D 6pack
Full product name	LEDClassic 5-50W MR16 840 60D 6pack
Full product code	871869681919700
Local code description	LED5MR16840NC6

Order code	929001280598
Material Nr. (12NC)	929001280598
Local order code	LED5MR16840NC6
Numerator - Quantity Per Pack	6
Net Weight (Piece)	0.040 kg
EAN/UPC - Product/Case	8718696819197
Numerator - Packs per outer box	4
EAN/UPC - Case	8718696819203

Dimensional drawing

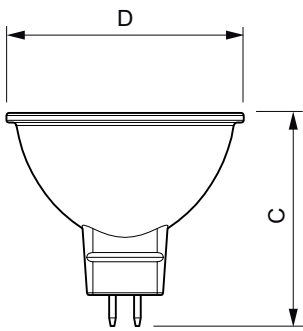

Product	D	C
LEDClassic 5-50W MR16 840 60D 6pack	50.5 mm	45.5 mm

Photometric data

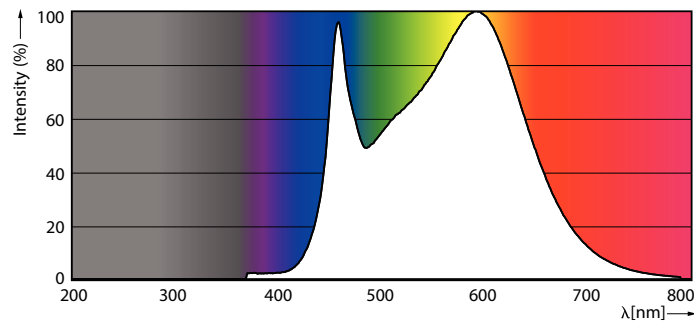

Spectral Power Distribution Colour - LEDClassic 5-50W MR16 840 60D 6pack

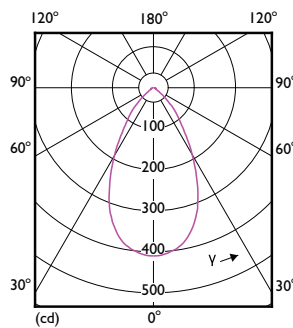

Light Distribution Diagram - LEDClassic 5-50W MR16 840 60D 6pack

Classic LEDspotLV

Photometric data

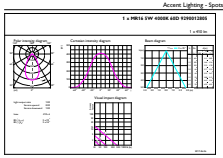

Classic Photometric Data Page Lighting LV Page 11

Accent Lighting Spots - LEDClassic 5-50W MR16 840 60D 6pack

Lifetime



Life Expectancy Diagram

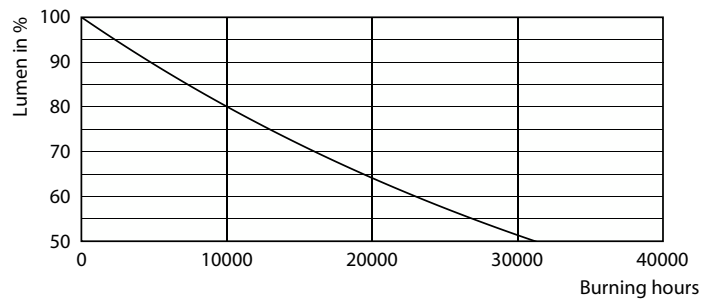

Lumen Maintenance Diagram

