

PHILIPS  
hue

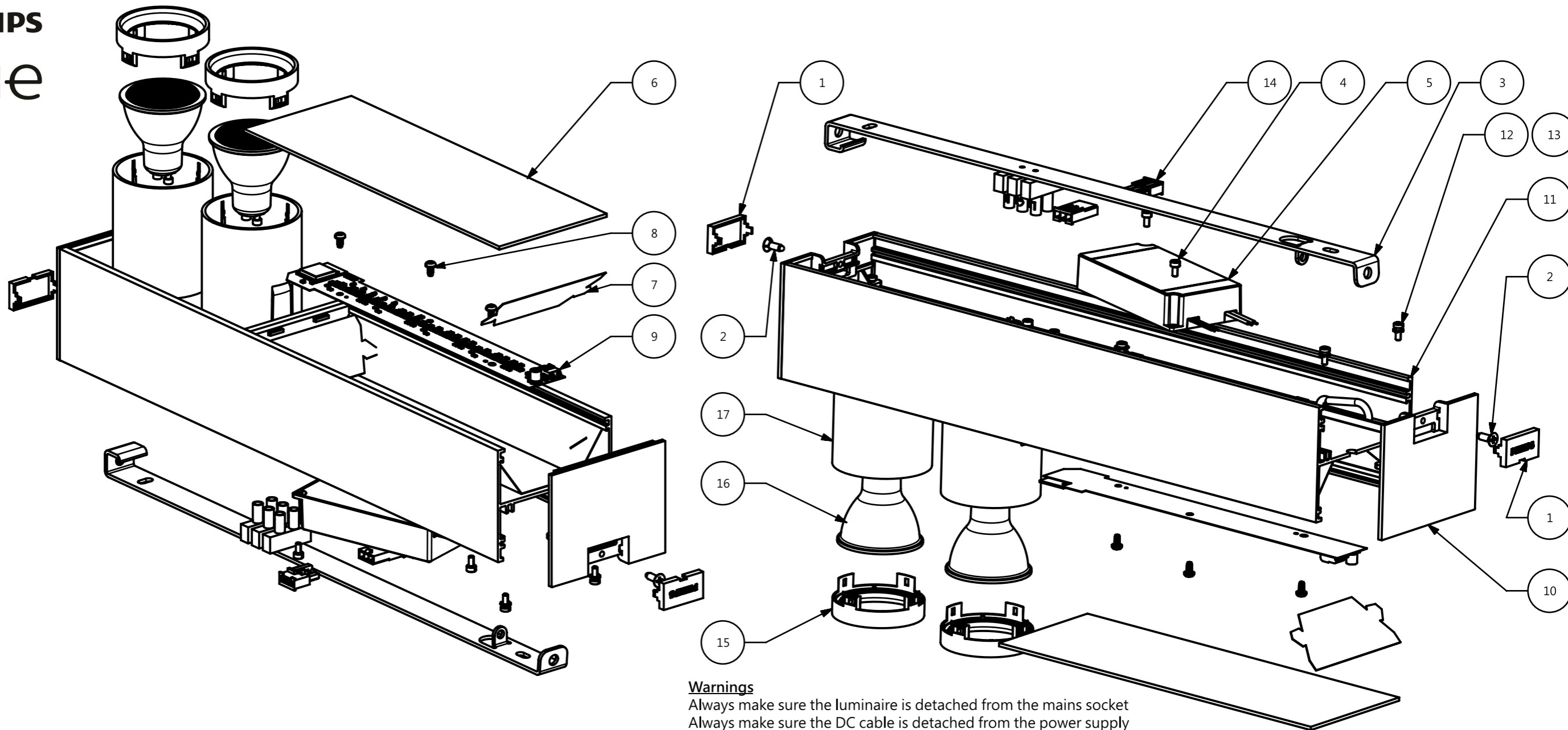

**Warnings**

Always make sure the luminaire is detached from the mains socket  
Always make sure the DC cable is detached from the power supply  
Staring at the operating light source may cause eye injury

#	COMPONENT	QTY
1	COVER	2
2	SCREW	2
3	BRACKET	1
4	SCREW	2
5	CONTROL GEAR - PSU	1
6	DIFFUSER	1
7	REFLECTOR	1
8	SCREW	3
9	LIGHT SOURCE - LED MODULE	1
10	END CAP	1
11	PROFILE	1
12	SCREW	2
13	WASHER	2
14	TERMINAL BLOCK	1
15	COVER	2
16	GU 10 BULB	2
17	TUBE	2

SKU	Color	Country
929003808501	WHITE	EU/UK
929003808401	BLACK	EU/UK

#	Disassembly Instructions	Tools needed
a	REMOVE BOTH COVERS (1) GENTLY LIFTING THEM OUT	FLATHEAD SCREWDRIVER
b	UNSCREW BOTH SCREWS (2)	CROSSHEAD SCREWDRIVER PZ
c	DISCONNECT TERMINAL BLOCK (14) SLIDING IT OUT AT THE SAME TIME PUSHING SAFETY LEVER ON IT	-
d	TAKE A SIDE BRACKET (3) UNHOOKING IT FROM END CAPS	-
e	REMOVE MARKED END CAP (10) BY UNSCREWING BOTH SCREWS (12)	TORXHEAD SCREW DRIVER T10
f	SLIDE OUT DIFFUSER (6)	
g	PULL OUT REFLECTOR (7)	
h	UNPLUG WIRES FROM LIGHT SOURCE-LED MODULE (9)	WAGO TOOL #2060
i	REMOVE LIGHT SOURCE-LED MODULE (9) BY UNSCREWING 3x SCREWS (8)	TORXHEAD SCREW DRIVER T10
j	CUT OUT MAIN WIRES OF CONTROL GEAR PSU (5)	CUTTING PLIERS
k	REMOVE CONTROL GEAR PSU (5) BY UNSCREWING SCREWS (4)	ALLEN KEY
l	REMOVE BOTH COVERS (15) ROTATING THEM AND PULLING OUT FROM TUBES (17)	
m	REMOVE GU 10 BULBS (16) ROTATING THEM OUT	

STATUS	DESCRIPTION	DESIGN ID	05	2024-04-29
	D1002356	D1002356		
	Centris Hue special form 2L white/black - Disassembly instruction	DOC 12NC		
NAME	Tom Ob	LOCAL PART ID	SH.	SH.
	CHECKED	DATE	1	511
		2021-08-04		A3-L
CONFIDENTIAL, PROPERTY OF: © 2021 Signify Holding				