

# PHILIPS

Capricorn  
9150051930

User manual

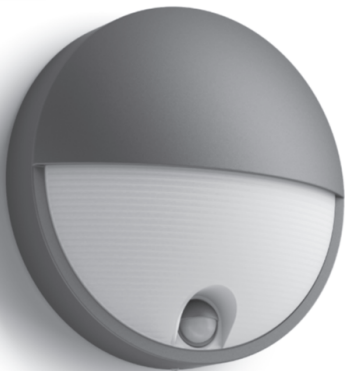

Incl.

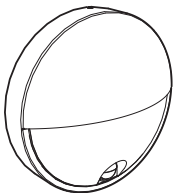

Excl.

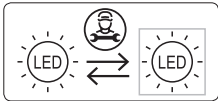
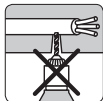
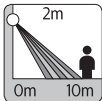
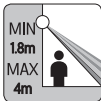
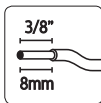
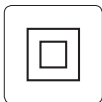
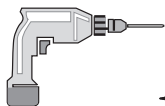

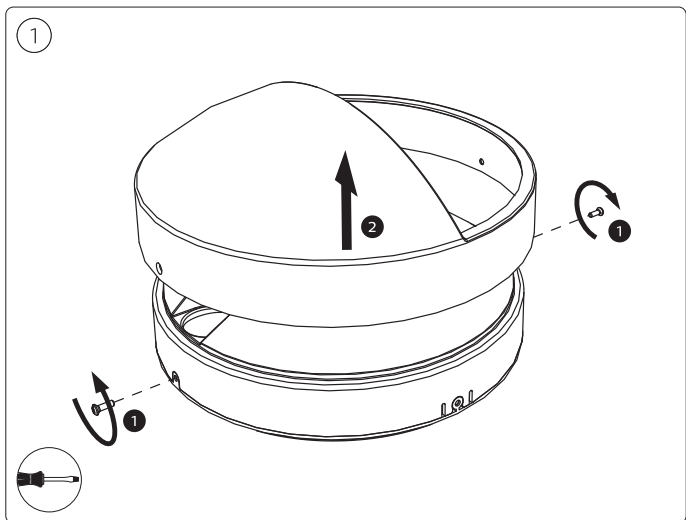
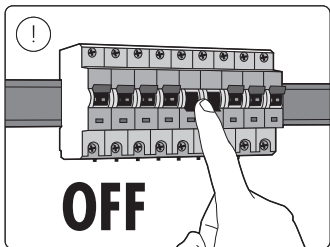
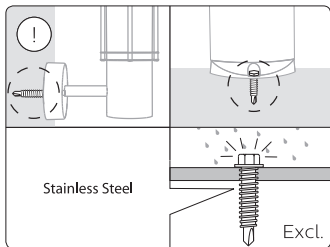

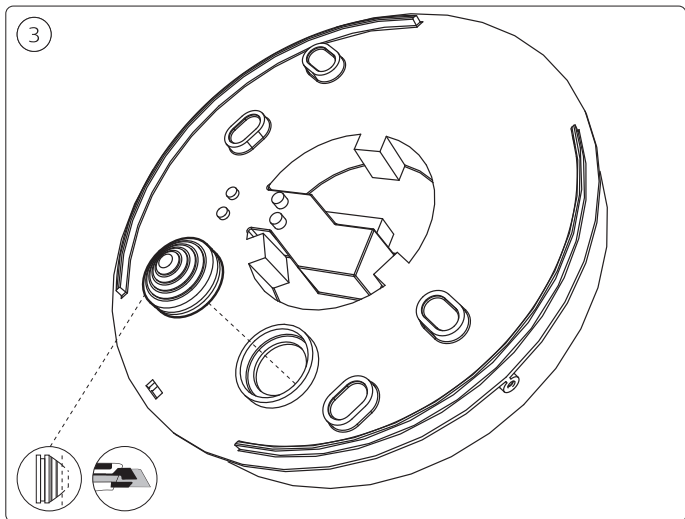
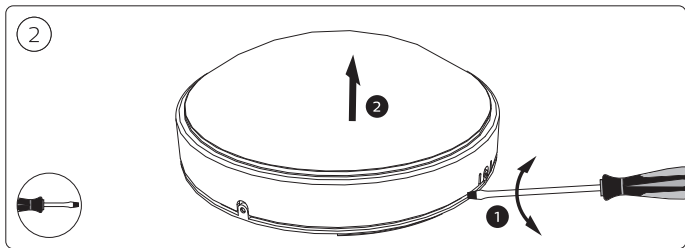

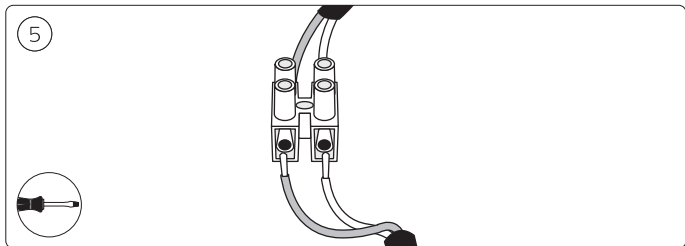
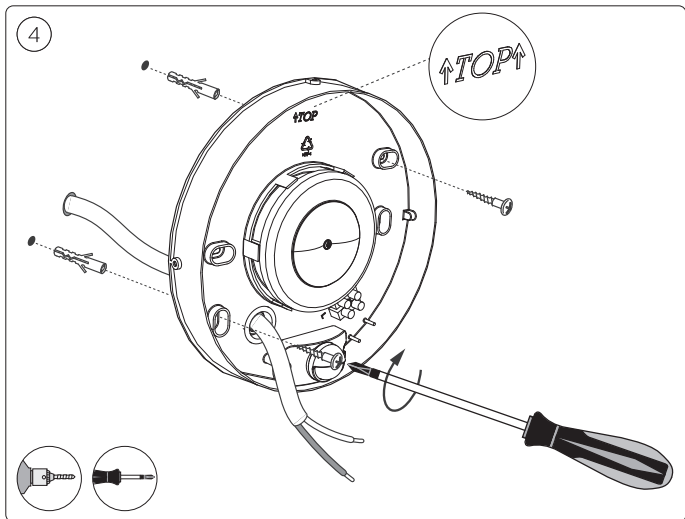

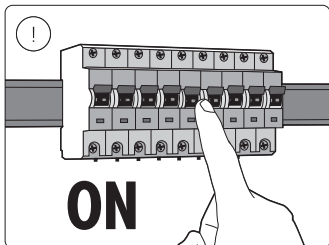
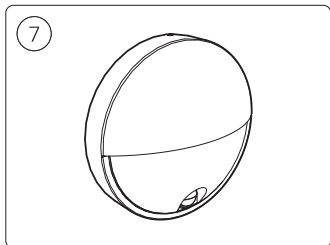
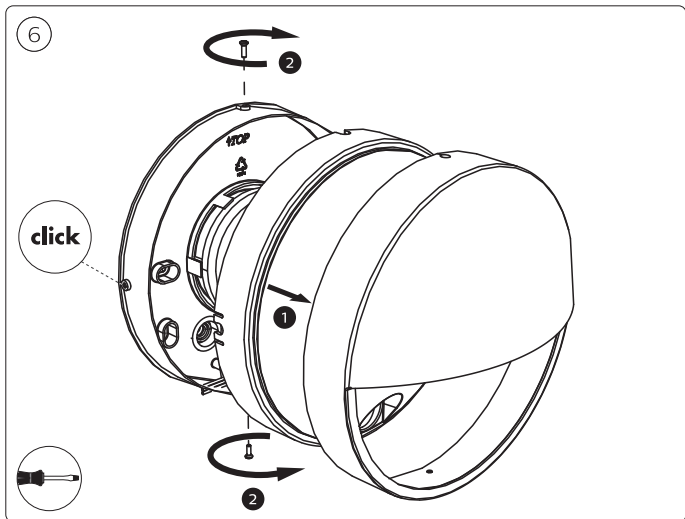

8a

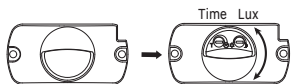

8b Time

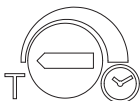

5 Sec  $\pm$  2 Sec



12 Min  $\pm$  3 Min



8c Lux

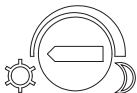

< 200Lux



< 30Lux





Signify Commercial UK Limited  
Unit 3, Guildford Business Park,  
Guildford, Surrey, GU2 8XG, UK

Signify  
I.B.R.S. / C.C.R.I. Numéro 10461  
5600 VB Eindhoven, the Netherlands  
☎00800-74454775

Philips and the Philips Shield Emblem  
are registered trademarks of Koninklijke  
Philips N.V. and are used under license.

[www.philips.com/lighting](http://www.philips.com/lighting)

© 2024 Signify Holding  
The Signify logo is a stylized lowercase "i" inside a circle, followed by the word "signify" in a lowercase, sans-serif font.

3241 660 99442