

PHILIPS

hue personal wireless lighting

Festavia string lights 500 LEDs



User manual
Benutzerhandbuch
Notice d'emploi
Manual de usuario
Manual do usuário
Manuale d'uso

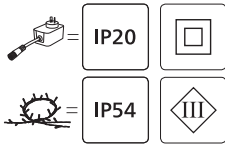
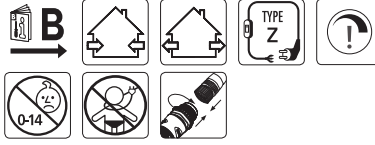
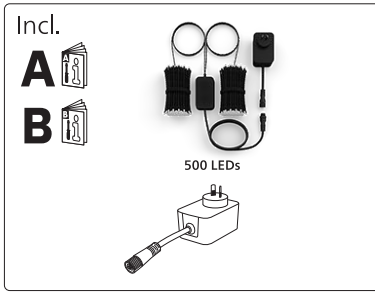

2

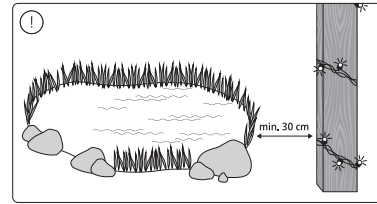
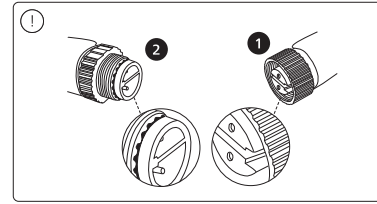
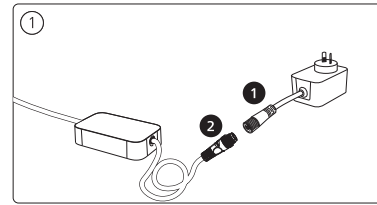

3



Signify (China) Investment Co., Ltd.
Building No. 9, Lane 888, Tianlin Road,
Minhang District, Shanghai, China
Postal code: 200233

www.philips-hue.com

442296350772

© 2024 Signify Holding
All rights reserved

Last update: 01/2024

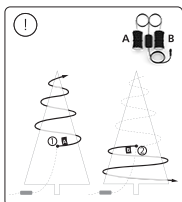
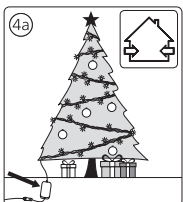
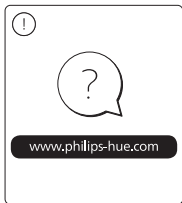
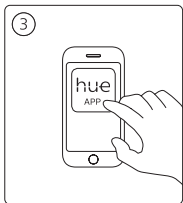
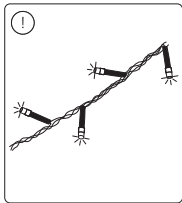
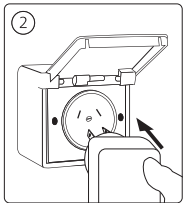

4

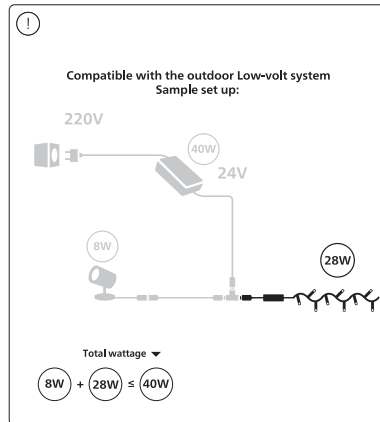
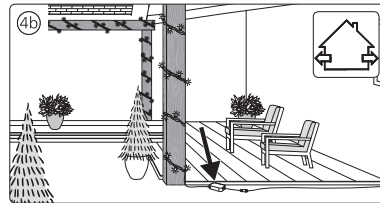

5

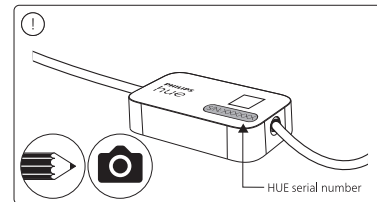
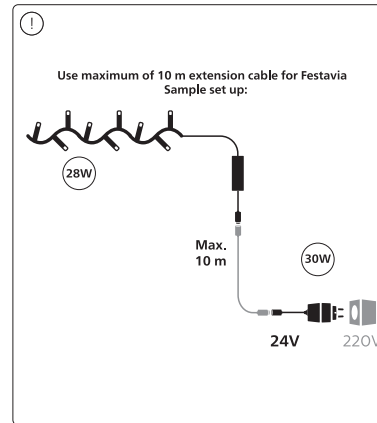

6

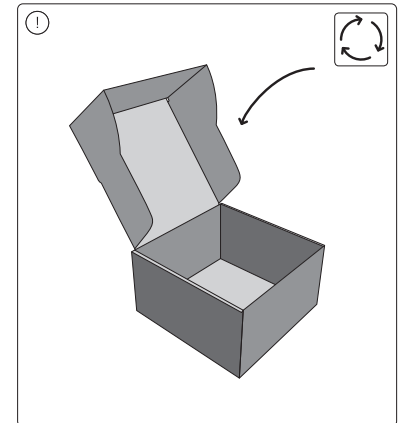

7