

PHILIPS

hue personal wireless lighting

Festavia string lights 100 / 250 LEDs



User manual
Benutzerhandbuch
Notice d'emploi
Manual de usuario
Manual do usuário
Manuale d'uso

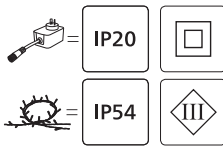
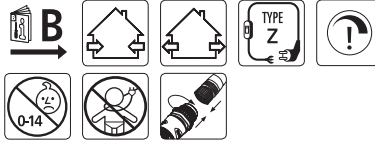
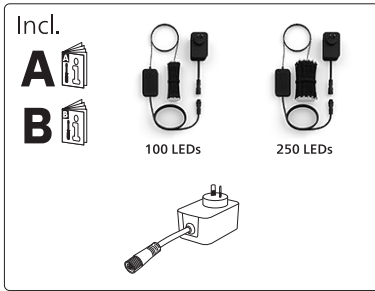

2

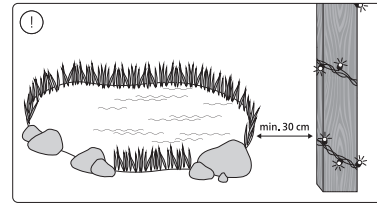
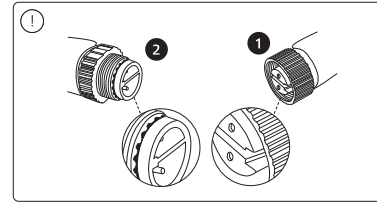
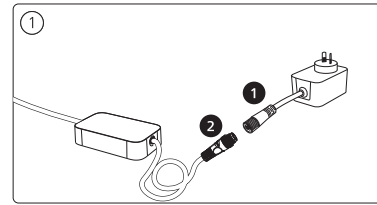

3



Signify (China) Investment Co., Ltd.
Building No. 9, Lane 888, Tianlin Road,
Minhang District, Shanghai, China
Postal code: 200233

www.philips-hue.com
442296350762

© 2024 Signify Holding
All rights reserved
Last update: 01/2024

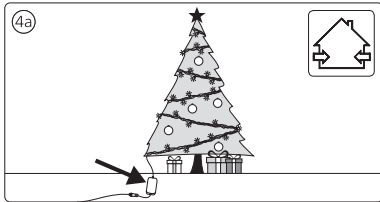
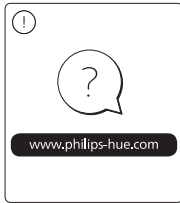
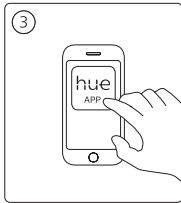
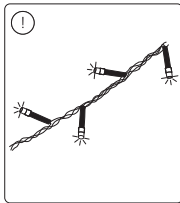
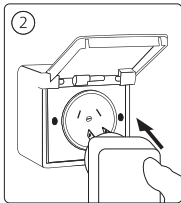

4

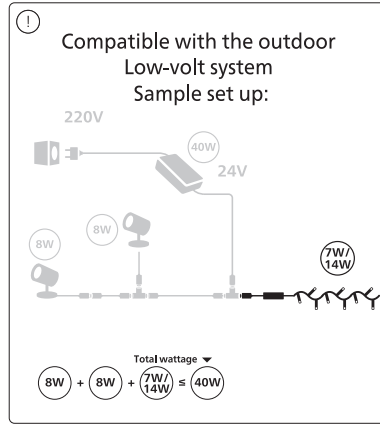
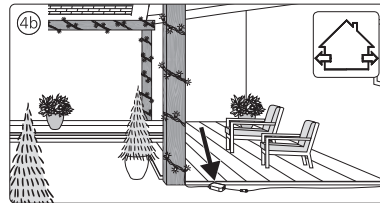

5

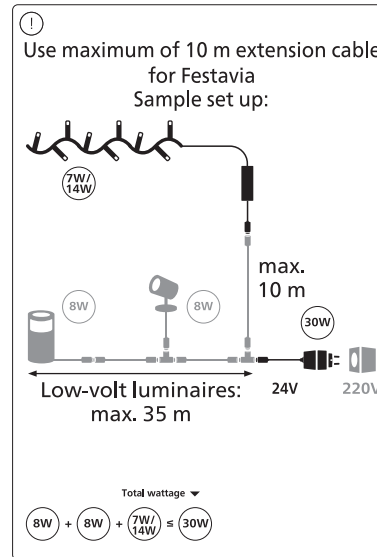

6

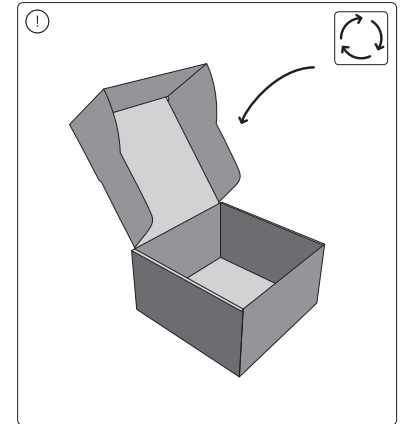
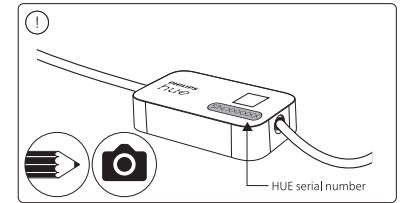

7