

**PHILIPS**

hue personal wireless lighting

Lightstrip 24"/27" monitor 3x Starter kit



HUE serial number

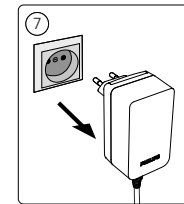
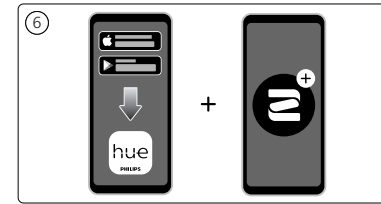
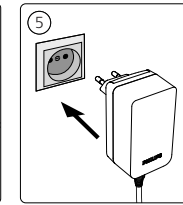
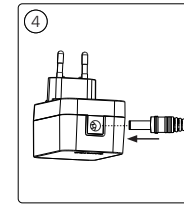
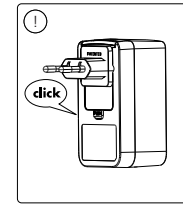
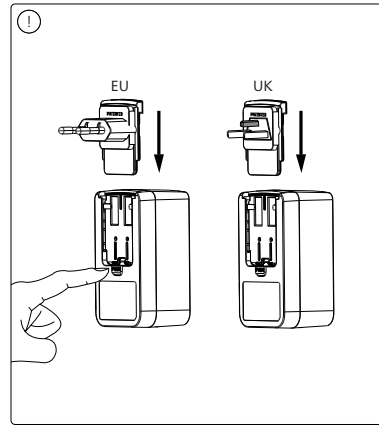
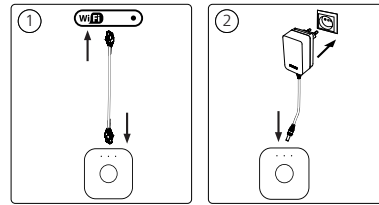
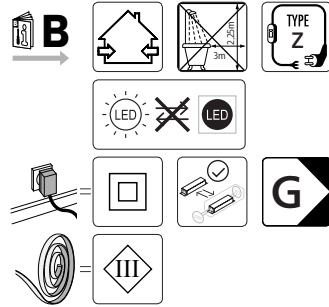
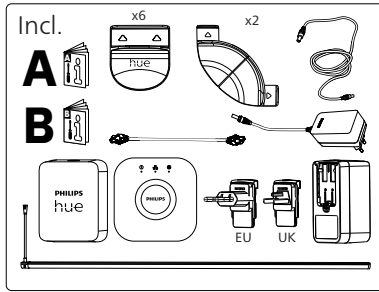

User manual  
Benutzerhandbuch  
Notice d'emploi  
Manual de usuario  
Manual do usuário  
Manuale d'uso

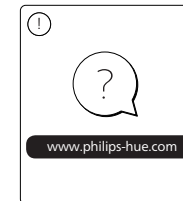
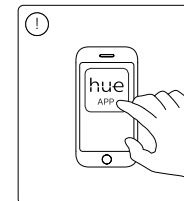
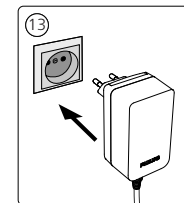
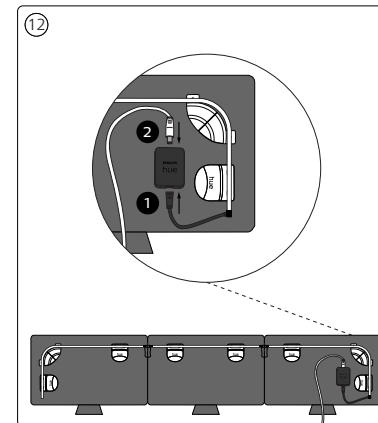
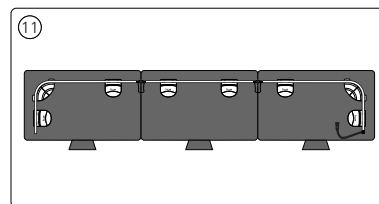
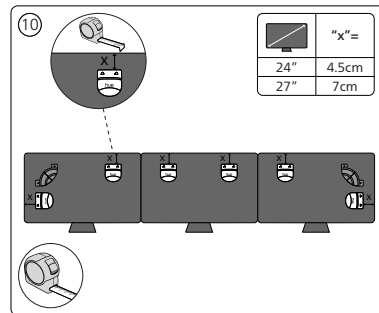
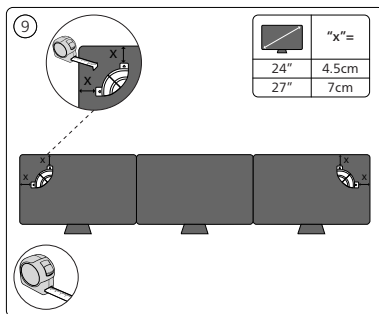
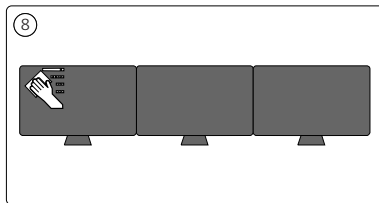

Signify  
I.B.R.S. / C.C.R.I. Numéro 10461  
5600 VB Eindhoven,  
the Netherlands  
000800-74454775

www.philips-hue.com

32226 391 0212  
Last update: 03/2022

© 2022 Signify Holding  
All rights reserved