

PHILIPS

Python

9290031880
9290031881



User manual
Benutzerhandbuch
Notice d'emploi
Manual de usuario
Manual do usuário
Manuale d'uso
Gebruiksaanwijzing

Incl.



Excl.

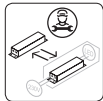
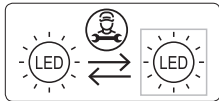
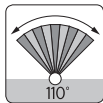
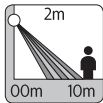
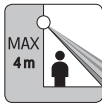
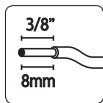
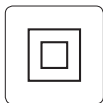
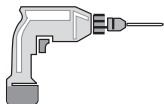

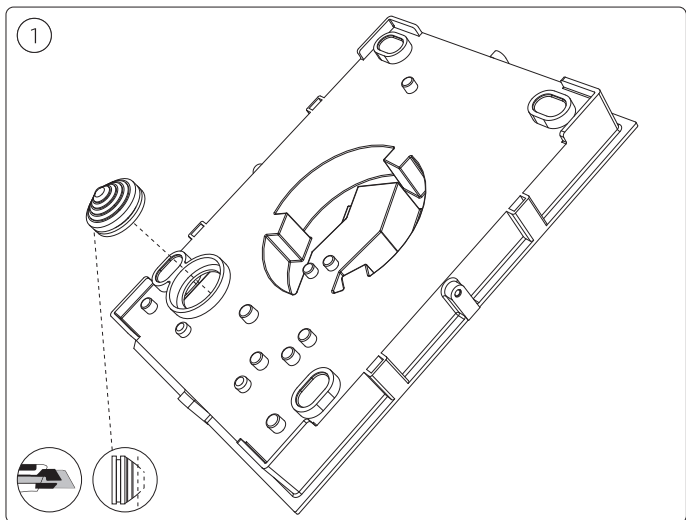
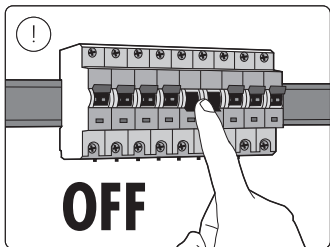
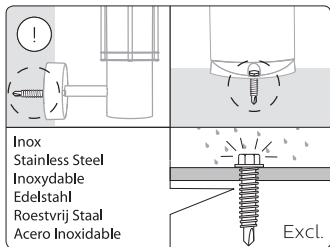

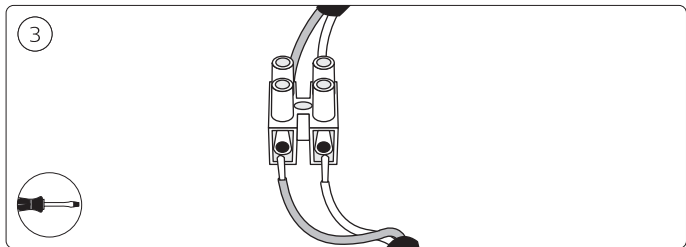
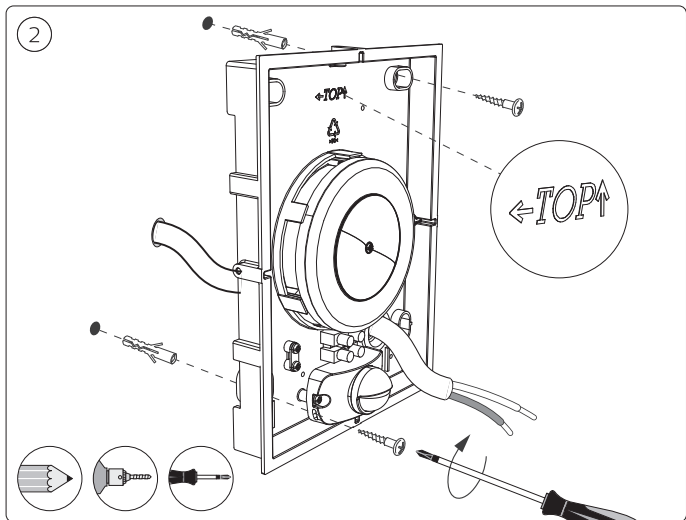

6a

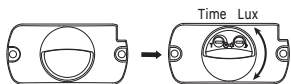

6b Time



5 Sec \pm 2 Sec



12 Min \pm 3 Min



6c Lux



< 200Lux



< 30Lux





Signify Commercial UK Limited
Unit 3, Guildford Business Park,
Guildford, Surrey, GU2 8XG, UK

Signify
I.B.R.S. / C.C.R.I. Numéro 10461
5600 VB Eindhoven, the Netherlands
☎00800-74454775

Philips and the Philips Shield Emblem
are registered trademarks of Koninklijke
Philips N.V. and are used under license.

www.philips.com/lighting

© 2024 Signify Holding
©signify

3241 658 90402