



**Lightolier CorePro LED Mini Track Heads** are a completely integrated LED luminaire. By combining the optics, light source, thermal management system and driver into a single housing, this luminaire provides a sleek look suitable for lower mounting heights and smaller spaces.

**Now including AccuRender technology for the highest color quality at the highest efficacy.**

Complete unit = Fixture + Reflector + Optional Accessories

Project: \_\_\_\_\_  
 Location: \_\_\_\_\_  
 Cat.No: \_\_\_\_\_  
 Type: \_\_\_\_\_  
 Qty: \_\_\_\_\_  
 Notes: \_\_\_\_\_

### Fixture

example: LTL08RNF927ALVA

Series	Adapters	Lumens	Beam Spread	CRI/CCT	Finish	Version
<b>LT</b>		<b>08</b>				<b>VA</b>
LT CorePro LED Mini Track Heads	L Lightolier H Halo J Juno	08 1000lm	RNF Narrow Flood 21° RWF Wide Flood 38°	927 90CRI/2700K 930 90CRI/3000K 935 90CRI/3500K 940 90CRI/4000K  LED Color Recipes CW30 90CRI / 3000K Crisp White PW30 90CRI / 3000K Premium White PC30 90CRI / 3000K Premium Color	AL Aluminum BK Matte Black WH Matte White	VA Version A

### Features

- Track attachment fitting:** Molded polycarbonate Integral color in gray, black or white. Rotates into place with the use of a push tab.
- Push tab:** Molded polycarbonate. Locks and detaches unit.
- Drive and optic housing:** Extruded aluminum. Steel eyelet friction connection. Rotates 180°.
- Movable contact:** Solid brass. Extends for connection to 2nd circuit in Advent track.
- Ground contact:** Solid brass.
- Integrated heat sink:** Passive cooling, integrated into optic and driver housing.
- Optics:** Single optic TIR (total internal reflection) optically clear thermoplastic. Prevents dust and contaminants from entering the luminaire.
- Light source:** COB LED.
- Finish:** Powder coat finish.
- Install:** suitable for wall & vertical surfaces.
- Crisp White:** Available in 90CRI/3000K only, our 90CRI CrispWhite technology combines the warm, saturated colors of high CRI with crisp and vibrant whites. The small form factor and high quality of light make this an impactful option for retail display areas
- Premium White:** Available in 90CRI/3000K, the new benchmark in retail fashion, delivering stronger, brighter whites via the best technology in the market, but with minimal compromise on energy savings.
- PremiumColor:** Available in 90CRI/3000K only, provides vivid and robust colors that pop while maintaining a strong ambient white and bold black balance in any space. This LED technology is sure to add positive energy to varying application needs.

### Electrical

**Electronic power supply**  
**Lumen Maintenance:** >80% of initial lumens at 100,000hrs.  
**Input voltage:** 120V, 50/60Hz  
**Input power:** 9W  
**Efficacy:** Up to 125lm/W  
**High power factor:** >0.9  
**CRI:** 90+

### Dimming Compatibility

**Trailing Edge (ELV) dimming compatibility**

Philips Controls	SR400RPC120	(100% - 4%)
Philips Controls	ZP425QE	(100% - 3%)
Lutron Skylark	S-300P	(100% - 5%)
Leviton Decora	IPE04	(100% - 5%)
Lutron	MAELV-600	(100% - 5%)
Leviton	6615-POW	(100% - 9%)

### Labels

cULus Listed. 5 year warranty.  
 ENERGY STAR® certified (excluding Crisp White, Premium White, and Premium Color configurations).

# LT CorePro LED

## Mini Track Heads (1000lm)

### Dimensions

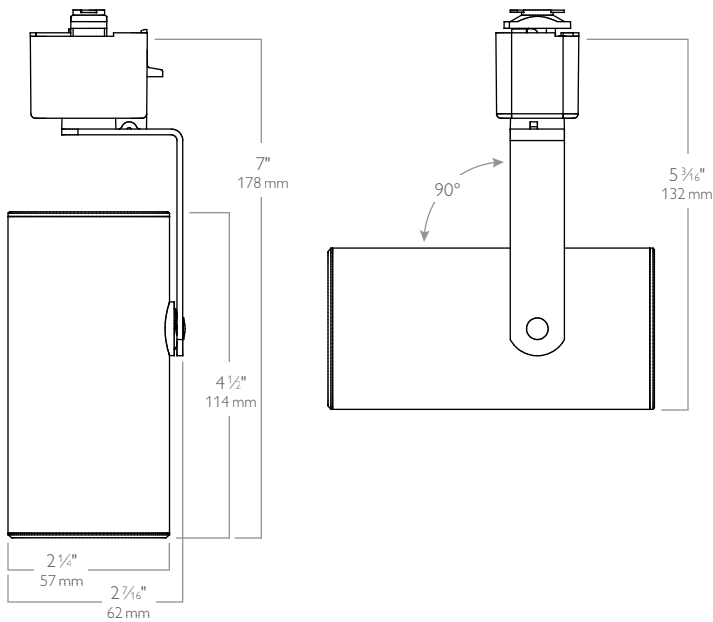

### Juno track adapter

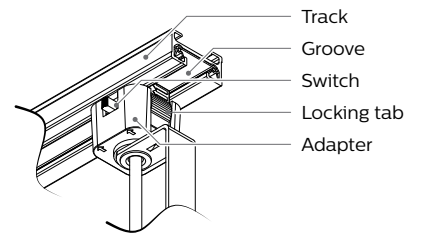
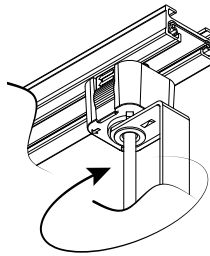

### Halo track adapter

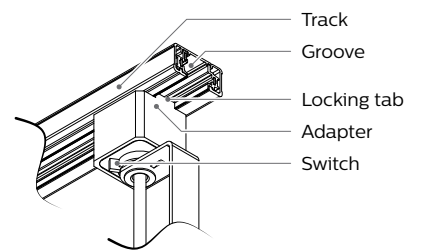
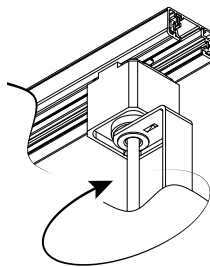

### Finishes



Aluminum



Black



White

# LT CorePro LED

## Mini Track Heads (1000lm)



### AccuRender Technology (CRI 90+)

The right light brings colors to life. Our new AccuRender technology helps ensure colors are rendered more accurately and consistently, while doing so as efficiently as CRI 80 products.



**Standard CRI 80**  
Good color rendering and high efficacy



**Standard CRI 90**  
Better color rendering and low efficacy



**AccuRender**  
Best color rendering, color preference and high efficacy

#### Enjoy design flexibility

Full range of products and options:

- Available soon in across Lightolier portfolio for application flexibility
- Multiple color temperatures (CCTs) and lumen packages offered

#### Promote savings

High efficacy, with no penalty:

- Energy efficacy compares well to conventional 80 CRI
- Up to 25% more energy savings vs competitor 90 CRI<sup>1</sup>
- Helps meet Title 24 requirements

#### Show your true colors

High color rendering:

- True to life colors to help energize your environment and render better flesh tones critical for healthcare hospitality and retail applications.
- $R_a$  up to 94 CRI
- $R_g$  up to 67 CRI
- $G_a$  up to 99 CRI
- $C_g$  up to 94 CRI
- $R_l$  up to 92 TM-30
- $R_{r,h1}$  up to 91 TM-30
- $R_g$  up to 100 TM-30
- $R_{cb,h1}$  up to -5% TM-30

#### Achieve color balance

Best in class color consistency:

- Promote aesthetic harmony in your space with  $\leq 2$  SDCM

#### LED Color Recipes

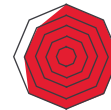
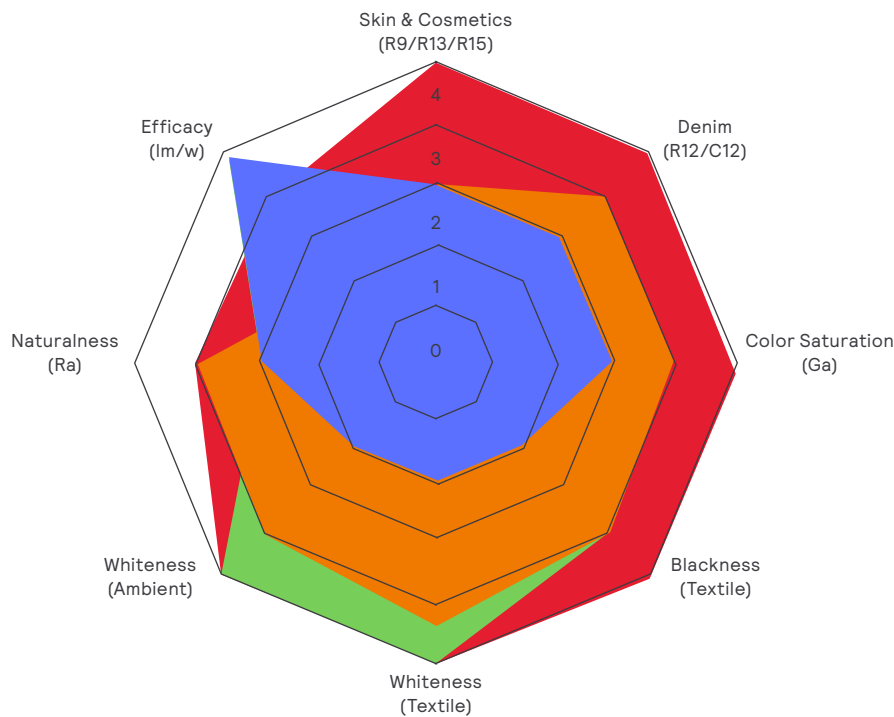

#### Crisp White

Dial-up the drama of your display. Highlight the variances in white tones, add contrast to blacks and create a real pleasing sparkle effect while retaining warm skin tones.

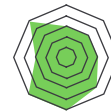

#### Premium White

The new benchmark for retail fashion. Delivering stronger and brighter whites via the best lighting technology on the market with minimal compromise to energy savings.



#### Premium Color

Enhance the contrast between colors and whites to achieve new depths of color rendering for a vibrant saturated fashion-forward visual experience that won't affect the atmosphere and will have a positive effect on energy efficiency.

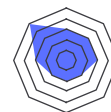

#### Standard Color

Standard CRI 90

# LT CorePro LED

## Mini Track Heads (1000lm)

### Photometry

Download  
1000lm  
IES Files



Download  
REVIT files  
& BIM files

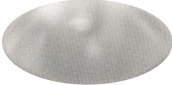
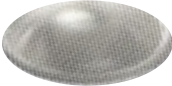

Beam Spread	Color Temp (CCT)	Beam Angle (FWHM)	Flux (lm)	CBCP	Energy (W)	Efficacy (lm/W)	CRI	R9
<b>Narrow Flood (RNF)</b>  	2700K	21°	942	4357	9.0	106	93	57
	3000K	21°	984	4552	9.0	111	94	60
	3500K	21°	1033	4776	9.0	116	93	59
	4000K	21°	1054	4873	9.0	118	93	60
	Crisp White	21°	751	3471	9.0	84	96	67
	Premium White	21°	999	4617	9.0	112	92	50
	Premium Color	21°	911	4210	9.0	102	93	78
<b>Wide Flood (RWF)</b>  	2700K	38°	1006	1817	9.0	112	93	57
	3000K	38°	1051	1899	9.0	117	94	60
	3500K	38°	1103	1992	9.0	123	93	59
	4000K	38°	1125	2032	9.0	125	93	60
	Crisp White	38°	801	1448	9.0	89	96	67
	Premium White	38°	1066	1926	9.0	118	92	50
	Premium Color	38°	972	1756	9.0	108	93	78

1. Luminaire photometry has been conducted in accordance with IES LM-79-08. IES files can be downloaded by clicking the links in the table above, or online at [lightolier.com](http://lightolier.com).
2. Crisp White, Premium White and Premium Color - 3000K results.
3. Color Rendering Index (CRI Ra) and Strong Red (R<sub>s</sub>) are calculated in accordance with CIE 013.3-1995.
4. Fidelity Index (Rf), Gamut Index (Rg), and Red Local Chroma Shift (Rcs,h1) are calculated in accordance with IES TM-30-18.

# LT CorePro LED

## Mini Track Heads (1000lm)

### Aiming Angles

L and W are the outer points where the candle power drops to 50% of the maximum. FC are the initial footcandles at the center of the beam. Data shown is for 3000K, use the table on the right for CRI/CCT adjustment factors.

- D Distance
- L Beam length
- W Beam Width
- A Aiming Angle
- C Distance to center beam
- FC Footcandles
- CBCP Center Beam Candlepower

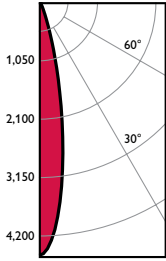
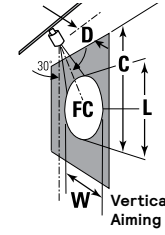
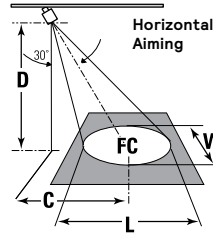

### 1000lm Narrow Flood

LTO8RNF930WHVA

CCT <sup>1</sup> :	3000K
Output lumens:	984 lms
Input watts <sup>2</sup> :	8.9 W
Efficacy:	110.6 lm/w
CRI:	90 min
CBCP:	4,552 cd

Beam Angle:	21.3°
Field Angle:	42.1°

#### 30° Aiming Angle

Horizontal Illuminance on floor

D	C	F.C.	L	W
6	3.5	82	3.0	2.6
8	4.6	46	4.1	3.5
10	5.8	30	5.1	4.3
12	6.9	21	6.1	5.2

#### 30° Aiming Angle

Vertical Illuminance on floor

D	C	F.C.	L	W
2	3.5	142	3.4	1.5
3	5.2	63	5.0	2.3
4	6.9	36	6.7	3.0
5	8.7	23	8.4	3.8

#### 60° Aiming Angle

Horizontal Illuminance on floor

D	C	F.C.	L	W
6	10.4	16	10.1	4.5
8	13.9	9	13.5	6.0
10	17.3	6	16.8	7.5
12	20.8	4	20.2	9.0

#### 60° Aiming Angle

Vertical Illuminance on floor

D	C	F.C.	L	W
2	1.2	739	1.0	0.9
3	1.7	328	1.5	1.3
4	2.3	185	2.0	1.7
5	2.9	118	2.5	2.2

CERTIFIED TEST REPORT NO. STMR-605

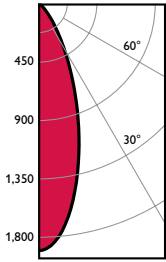

### 1000lm Wide Flood

LTO8RWF930WHVA

CCT <sup>1</sup> :	3000K
Output lumens:	1051 lms
Input watts <sup>2</sup> :	9.0 W
Efficacy:	116.8 lm/w
CRI:	90 min
CBCP:	1,899 cd

Beam Angle:	37.7°
Field Angle:	75.3°

#### 30° Aiming Angle

Horizontal Illuminance on floor

D	C	F.C.	L	W
6	3.5	34	5.7	4.7
8	4.6	19	7.6	6.3
10	5.8	12	9.5	7.9
12	6.9	9	11.4	9.5

#### 30° Aiming Angle

Vertical Illuminance on floor

D	C	F.C.	L	W
2	3.5	59	8.4	2.7
3	5.2	26	12.6	4.1
4	6.9	15	16.8	5.5
5	8.7	9	21.0	6.8

#### 60° Aiming Angle

Horizontal Illuminance on floor

D	C	F.C.	L	W
6	10.4	7	25.2	8.2
8	13.9	4	33.6	10.9
10	17.3	2	42.0	13.7
12	20.8	2	50.4	16.4

#### 60° Aiming Angle

Vertical Illuminance on floor

D	C	F.C.	L	W
2	1.2	308	1.9	1.6
3	1.7	137	2.8	2.4
4	2.3	77	3.8	3.2
5	2.9	49	4.7	3.9

CERTIFIED TEST REPORT NO. STMR-606



© 2021 Signify Holding. All rights reserved. The information provided herein is subject to change, without notice. Signify does not give any representation or warranty as to the accuracy or completeness of the information included herein and shall not be liable for any action in reliance thereon. The information presented in this document is not intended as any commercial offer and does not form part of any quotation or contract, unless otherwise agreed by Signify.

Signify North America Corporation  
400 Crossing Blvd, Suite 600  
Bridgewater, NJ 08807  
Telephone: 855-486-2216

Signify Canada Ltd.  
281 Hillmount Road,  
Markham, ON, Canada L6C 2S3  
Telephone: 800-668-9008

All trademarks are owned by Signify Holding or their respective owners.