



Greengate

P/N 9850-000287-02

NeoSwitch Passive Infrared (PIR) Dual Relay Vacancy Sensing Wall Switch (Ground Required)



RoHS

Model # VNW-P-1001-DMV-W
Model # VNW-P-1001-DMV-V
Model # VNW-P-1001-DMV-G

General Information

- Read all instructions on both sides of this sheet first
- Install in accordance with ALL local codes
- For indoor use only

Specifications

Technology: Passive Infrared (PIR)

Electrical Ratings:

120 VAC:

- Incandescent/Tungsten – Max. load: 6.7 amps, 800W, 50/60 Hz
- Fluorescent/Ballast – Max. load: 10 amps, 1200W, 50/60 Hz

Motor Load: ¼ HP @ 125 VAC

277 VAC:

- Fluorescent/Ballast – Max. load: 9.8 amps, 2700W, 50/60 Hz

Ballast Compatibility: Compatible with magnetic and electronic ballasts

No Minimum Load Requirement

Time Delays: Self-Adjusting, 15 seconds/test (10 min Auto), Selectable 5, 15, 30 minutes

Coverage: Major motion – 1000 sq. ft.
Minor motion – 300 sq. ft.

Light Level Sensing: 0 to 200 foot-candles

Operating Environment:

- Temperature: 32° F – 104° F (0° C – 40° C)
- Relative Humidity: 20% to 90% non-condensing

Housing: Durable, injection molded housing.

Polycarbonate resin complies with UL94V0.

Size:

- Mounting Plate/Strap Dimensions: 4.195" H x 1.732" W (106.553 mm x 44 mm)
- Product Housing Dimensions: 2.618" H x 1.752" W x 1.9" D (66.5 mm x 44.5 mm x 48.26 mm)

LED Indicators: Red LED indicates PIR detection; Green LED acts as EcoMeter or night light locator.

EcoMeter Operation		
Load 1	Load 2	EcoMeter LED
OFF	OFF	100%
ON	OFF	50%
OFF	ON	50%
ON	ON	OFF

Action	EcoMeter	Benefit
A person enters the space and one of the loads is activated	50%	Increased awareness of energy savings
Both loads are ON	OFF	
The area is vacated and the lights turn OFF automatically	100%	Increased awareness of energy savings; Acts as a night light locator
A person turns the lights OFF manually upon exiting an area	100%	Increased awareness of energy savings and reminds individuals to take control of their lighting for additional savings; Acts as a night light locator
If the daylighting function is activated for one of the two loads and there is sufficient daylight in the space, the unit will hold that load OFF	50%	Increased awareness of energy savings; Lets persons know that the daylight sensor is holding the lights OFF; Acts as a night light locator
If the daylighting function is activated for both loads and there is sufficient daylight in the space, the unit will hold that loads OFF	100%	Increased awareness of energy savings; Lets persons know that the daylight sensor is holding the lights OFF; Acts as a night light locator

Coverage

The VNW-P-1001-DMV is designed for offices up to 300 square feet.

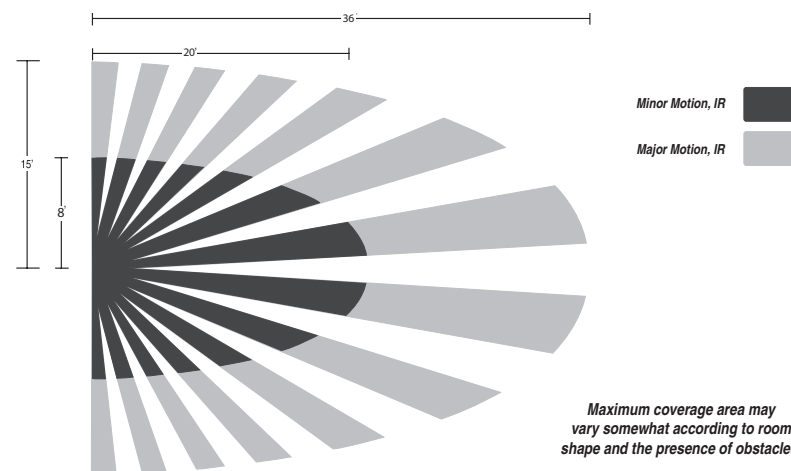

Description

The VNW-P-1001-DMV Vacancy Sensing Wall Switch is a Passive Infrared (PIR) motion sensing lighting control and conventional wall switch all-in-one, used for energy savings and convenience.

PIR Technology

The sensor's segmented lens divides the field of view into sensor zones, and detects the changes in temperature that are created when a person, or part of a person as small as a hand, passes into or out of a sensor zone.

The VNW-P-1001-DMV allows the control of two separate loads with one occupancy sensor switch.

The lights are turned ON by pressing the universally recognized light icon pushbutton. In either mode, the lights stay ON as long as the sensor detects motion in the room. When the room is vacated, the lights turn OFF automatically after a preset Time Delay interval.

The sensor includes self-adaptive technology that continually adjusts to conditions by adjusting sensitivity and time delay in real-time. By adjusting sensitivity and time delay automatically, the sensor is maximizing the potential energy savings that are available in the particular application.

The EcoMeter provides a visual indicator of energy usage, increasing end user awareness and reminding individuals to take control of their lighting to maximize energy savings.

The Daylighting feature prevents lights from turning ON, when the room is adequately illuminated by natural light.

Bathroom Mode – When selected, bathroom mode keeps the second relay ON for an additional 8 minutes, after the first relay has been turned off. Combine this with changing the pushbutton to the light/fan graphic and you now have the universally recognized and easy to use bathroom solution.

Relay Swap Option – A common problem in electric wiring is wiring the wrong switch to the wrong load. This can make control of loads confusing to an end user. The Relay Swap option solves the problem by allowing the switch buttons on the face of the unit to be swapped, after the unit is wired and installed.

Location

When installing the VNW-P-1001-DMV in a new junction box, choose the switch location carefully to provide optimum coverage of the occupied area. When replacing an existing wall switch, bear in mind that there must be a clear line-of-sight between the sensor and the area to be covered. Avoid pointing the VNW-P-1001-DMV directly into the hallway where it may detect passers-by.

Installation

The VNW-P-1001-DMV can be installed in any standard single gang box. It may be installed in the same manner as an ordinary wall switch.

- Wire the VNW-P-1001-DMV as described in the wiring section.
- Mount the VNW-P-1001-DMV in the junction box.

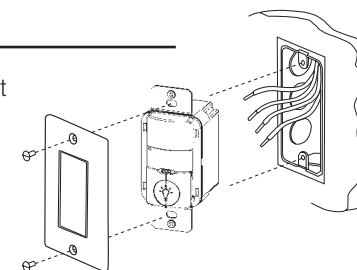

Wiring

CAUTION: Before installing or performing any service on a Greengate system, the power **MUST** be turned OFF at the branch circuit breaker. According to NEC 240-83(d), if the branch circuit breaker is used as the main switch for a fluorescent lighting circuit, the circuit breaker should be marked "SWD." All installations should be in compliance with the National Electric Code and all state and local codes.

NOTE REGARDING COMPACT FLUORESCENT LAMPS: The life of some compact fluorescent lamps (CFLs) is shortened by frequent automatic or manual switching. Check with CFL and ballast manufacturer to determine the effects of cycling.

- Make sure power is turned OFF at the branch circuit breaker.
- Wire units as shown in wiring diagrams per applicable voltage requirements.
- Mount unit to wall box.
- Turn power back ON at the branch circuit breaker and wait 2 minutes for the unit to stabilize.
- Make necessary adjustments. (See Checkout and Adjustments section)
- Install wall switch plate.

Wiring Diagram 1: 120/277 VAC dual level single circuit wiring diagram

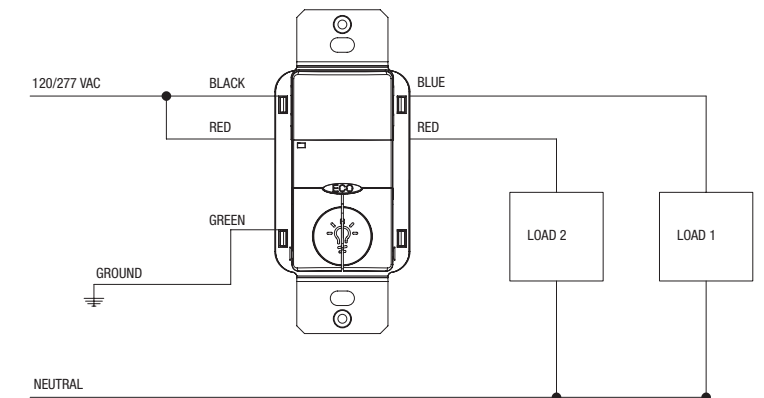

Wiring Diagram 2: 120/277 VAC dual level dual circuit wiring diagram

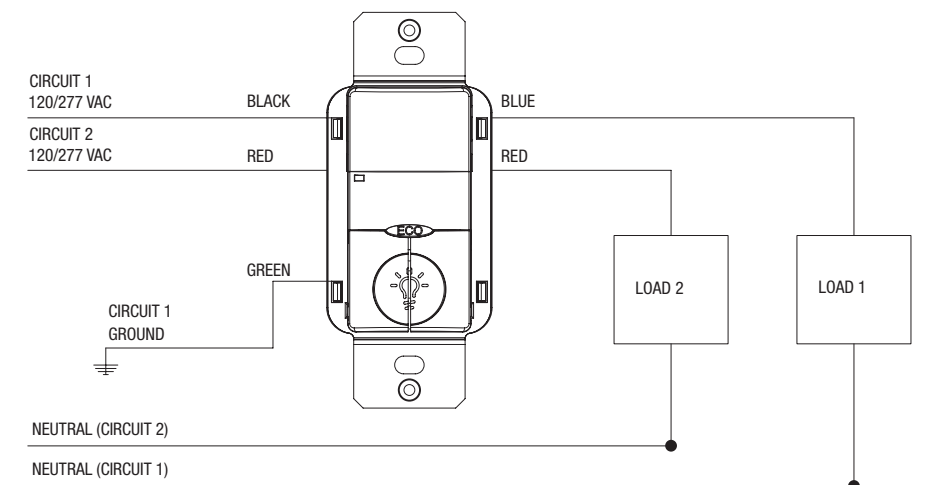

Wiring Diagram 3: 120/277 VAC dual level single circuit three-way wiring diagram

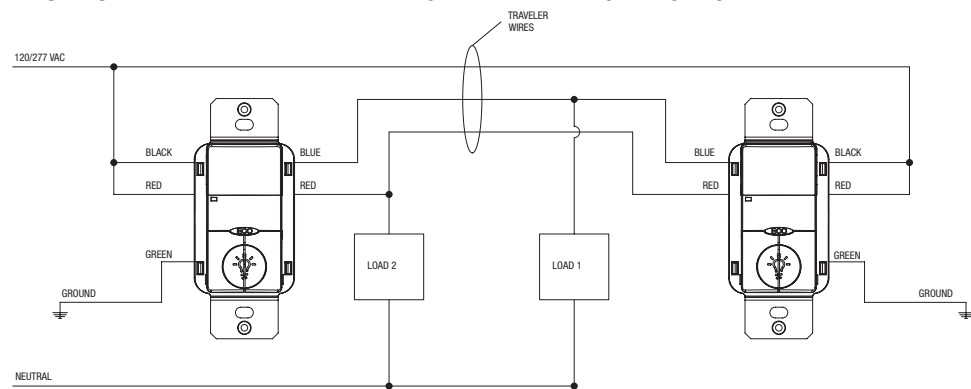

THREE-WAY WIRING DIAGRAM:
LIGHTS WILL TURN OFF, WHEN UNIT THAT WAS TURNED ON LAST AND/OR DETECTED MOTION LAST TIMES-OUT

CAUTION: If a room is wired for two circuits using two separate hot leads, it is very important to connect only one circuit per relay. Both circuits must be fed from the same phase.

DIP Switch Settings

DIP Switch Legend

DIP Switch	Time Delay		Not Used		PIR Sensitivity	Not Used		EcoMeter	Override	Bathroom	Relay Swap	Daylighting	
	1	2	3	4		5	6					7	8
Auto*	▼	▼			Full			Enable	Disable	Disable	Normal	Disable	Disable
5 Minutes	▼	▲			50%			Disable	Enable	Enable	Swap	Enable	Enable
15 Minutes	▲	▼											
30 Minutes	▲	▲											

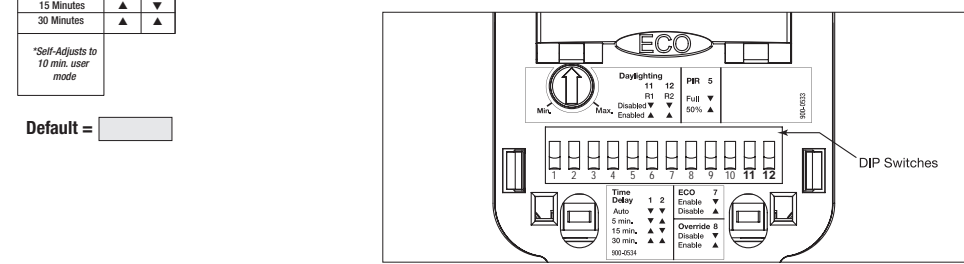

*Self-Adjusts to 10 min. user mode

Default =

Checkout and Adjustment

Adjustments should be made with the HVAC system on so that the installer will be able to detect the effect of airflow on the operation of the VNW-P-1001-DMV. Use only insulated tools to make adjustments.

Immediately after applying power to the lighting circuit, wait approximately two minutes for the switch to power up and stabilize.

Self-Adjust

Sensor is shipped in Self-Adjust Mode. This applies to time delay and PIR sensitivity. In preparation for the Installer Test, the time delay is set to 15 seconds, after the sensor is installed, powered ON and has stabilized, the unit will time-out 15 seconds after the last motion detected. Coverage and sensitivity can be confirmed by watching the Red (PIR) indicator LED on the front of the sensor, while moving around the room.

1. Walk around the room and monitor LEDs.
2. Stand in different parts of the room and wave your hands. LED should only turn ON for one second with each motion. (If LED does not turn ON, go to Installer Adjustments –Sensitivity Adjustment Section)
3. Stand still three to four feet away from sensor for five seconds. LED should not turn ON. (If LED turns ON, go to Installer Adjustments –Sensitivity Adjustments section)

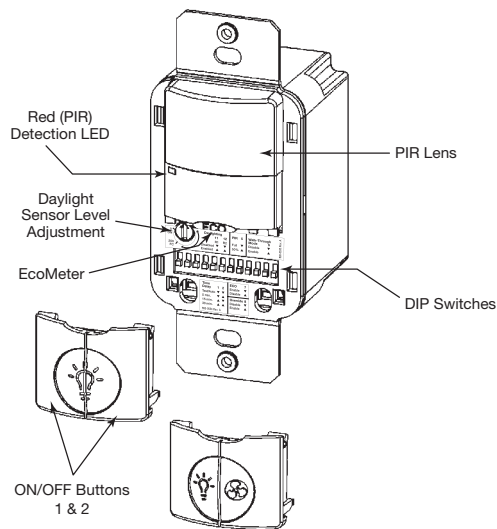

4. Walk outside the room and wait 15 seconds for the lights to turn OFF. (If lights do not turn OFF go to Installer Adjustments Section)
5. Re-enter the room and manually activate the sensor. (If lights do not turn ON go to Troubleshooting Section)
6. At this point you can exit the room and let the sensor time-out. When the sensor times-out and is inactive for five minutes, the unit will go to a 10 minute Time Delay user mode setting.

Note: To place into Test Mode, toggle DIP Switch 12 out of its current position, wait 3 seconds, and then back into its original position.

Installer Adjustments

PIR Sensitivity

1. Stand in different areas of the room and wave your hands.
2. If the Red LED does not turn ON, check for any obstructions.
3. Stand still three to four feet away from sensor for five seconds. LED should not turn ON.
4. If Red LED turns ON without motion or is constantly ON adjust PIR sensitivity to 50% by moving DIP Switch 5 up.

Field-of-view outside the space

1. Adjust PIR sensitivity to 50% by moving DIP Switch 5 up.
2. Use non-reflective tape strips to cover the portions of the sensor lens that view outside the space.

Daylight Adjustments

The Daylighting feature prevents the lights from turning ON when the room is adequately illuminated by natural light. If there is enough light in the room regardless of occupancy, the sensor will hold the lights OFF. If there is not enough light in the room, the sensor will allow the lights to turn ON. The Daylighting feature allows the selection of which relay to control via daylighting (dual load models only). The sensor will not allow the Daylighting feature to turn the load OFF until the space is vacant if the light level rises above the setpoint and the Time Delay expires. If someone attempts to turn the load ON and there is sufficient daylight available the Daylighting feature will hold the lights OFF.

1. Set the light level when the ambient light is at the level where no artificial light is needed. If this feature is not needed, leave the light level at maximum (fully CW).
2. Set DIP Switches 11 (Relay 1) and/or 12 (Relay 2) for daylight control.
3. With the load(s) ON, put the sensor into Test Mode. To place into Test Mode, toggle DIP Switch 12 out of its current position, wait 3 seconds and then back in to its original position.
4. Set the light level to minimum (fully CCW).
5. Let the sensor time-out so lights are OFF. Enter the space and lights should remain OFF.
6. Make sure not to block the sensor from the daylight source and adjust the light level potentiometer CW in small increments. (Pause 5 seconds between each adjustment)
7. Lights will not turn ON upon manual activation, when the ambient light level exceeds the daylight threshold setting.

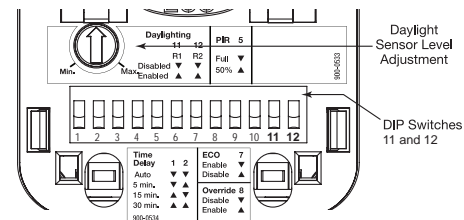

Time Delay Adjustments

People who remain very still for long periods of time may need a longer time delay than the default setting of 10 minutes. As long as the self-adjusting feature is enabled, the switch will respond to each pair of false-offs with no normal OFF in between, by alternately making slight adjustments to either time delay (by 2 minute increments) or sensitivity, so there should be no need for manual adjustment. If manual adjustment is desired, refer to Time Delay settings in DIP Switch legend.

Reset sensor Time Delay to factory settings by moving DIP Switches 1 and 2 down. (If DIP Switches 1 and 2 are already down, toggle DIP Switch 1 out of its current position, wait 3 seconds, and then back to its original position)

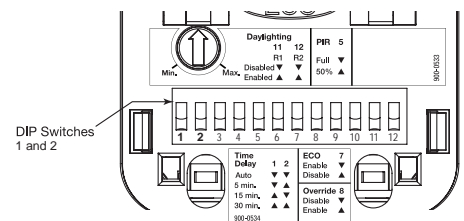

Override

- The Override setting allows the sensor to operate as a service switch in the unlikely event of failure.
1. Move DIP Switch 8 up.
 2. The pushbutton can be used to manually turn lights ON or OFF.

Troubleshooting

Issue	Possible Causes	Suggestions
Lights Will Not Turn ON manually	Daylight Feature Enabled	If all lights are required adjust DIP Switches 11 and 12 and/or daylight potentiometer.
	Power interruption	Check incoming voltage and/or wiring.
If lights will still not turn ON, set sensor to override mode and call Technical Services at 1-800-553-3879		
Lights Will Not Turn OFF automatically	Override	Make sure sensor is not in Override Mode (DIP Switch 8 up).
	Self-Adjust	If sensor is in Self-Adjust Mode, it may be possible for the unit to have increased the Time Delay to a 30 minute delay. If the lights do not turn OFF after 30 minutes follow next step.
	30 Minute Delay	Maximum Time Delay is 30 Minutes. Check DIP Switches to verify DIP Switch settings. If lights do not turn OFF at the set Time Delay, check next step.
Lights Will Not Turn OFF manually	PIR activated by heat source other than occupant	Move DIP Switch 5 up.
		Call Technical Services
If lights will still not turn OFF, call Technical Services at 1-800-553-3879		

Warranties and Limitation of Liability

Please refer to www.cooperlighting.com under the Legal section for our terms and conditions.