

PHILIPS

LED Outdoor Solar Spotlight
Projecteur solaire
DEL d'extérieur
9290041357

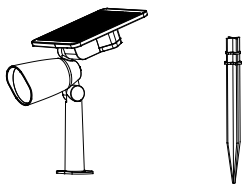

Incl.



x 2



x 2



x 2

Excl.

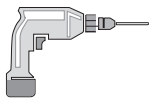

FC

IP44

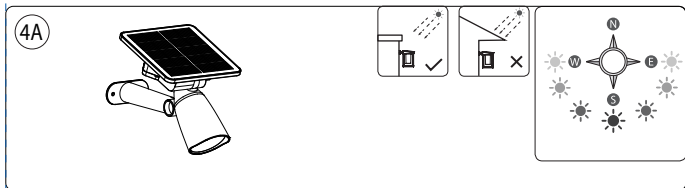
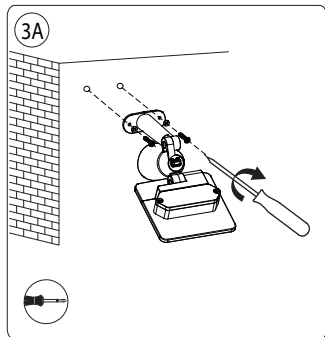
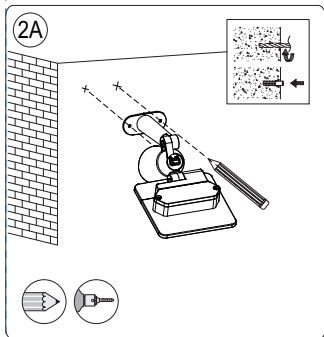
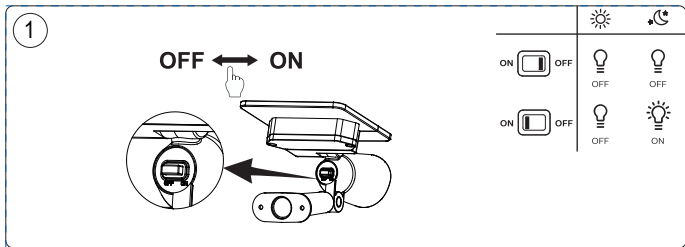

2B

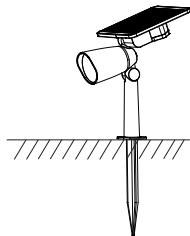
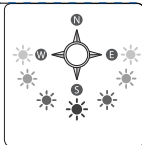
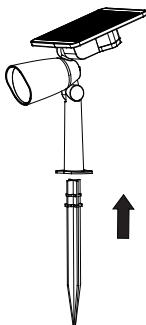

EN When putting the stake in the ground, avoid using a hammer.
For hard ground, use water and/or a tool to loosen the soil.

FR Pour planter le piquet dans le sol, éviter d'employer un marteau. Pour un sol dur, utiliser plutôt de l'eau ou un outil pour ramollir le sol.

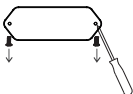
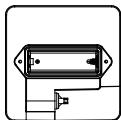
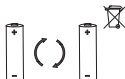
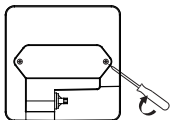
**1****2****3**

EN BUTTON-TOP WITH PROTECTION CIRCUIT LI-ION 18650 3.7V BATTERY ONLY
MINIMUM BATTERY CAPACITY 2000mAh

FR UNIQUEMENT PILE LI-ION 3,7 V 18650 AVEC DESSUS À BOUTON ET CIRCUIT DE PROTECTION
CAPACITÉ MINIMALE DE LA PILE 2000 mAh

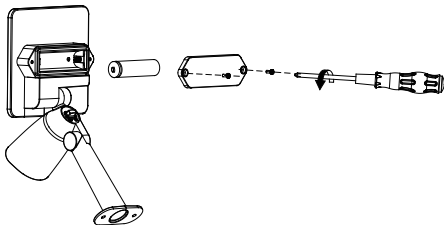



En México por:
Signify Mexico S.A. de C.V.
Av. La Palma N° 6-Col.
La Herradura Huixquilucan
Edo. De México, C.P. 52784 -
R.F.C. PME-620620-E84
Centro de Contacto 800-508-9000

Signify North America Corporation
400 Crossing Blvd, Suite 600
Bridgewater, NJ 08807, USA

Signify Canada Ltd./Signify Canada Ltée
281 Hillmount Road,
Markham, ON, Canada L6C 2S3

Philips and the Philips Shield Emblem
are registered trademarks of Koninklijke
Philips N.V. and are used under license.

www.philips.com/lighting

© 2024 Signify Holding

Signify

3241 661 75461