

# PHILIPS

hue personal  
wireless  
lighting

Centris



Hue serial number:

1

2

3

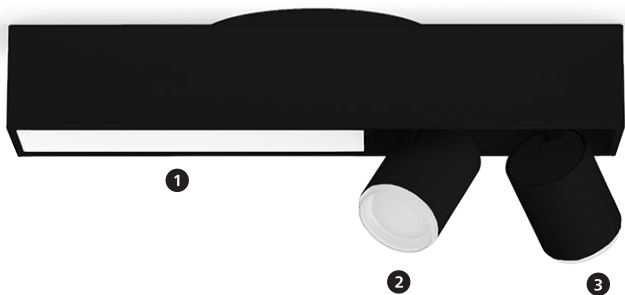

User manual  
Notice d'emploi  
Manual de usuario

Incl.

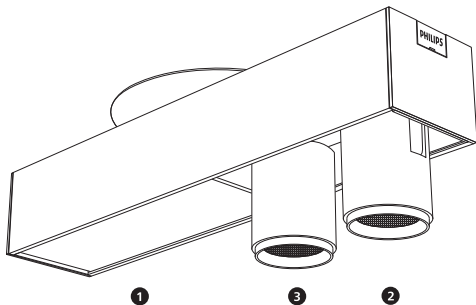
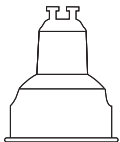

**1**  
**2**  
**3** MAX. 6 W

Excl.

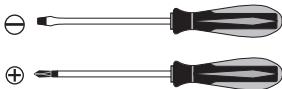
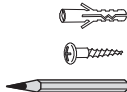
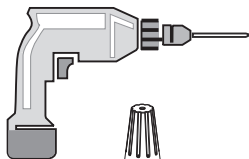

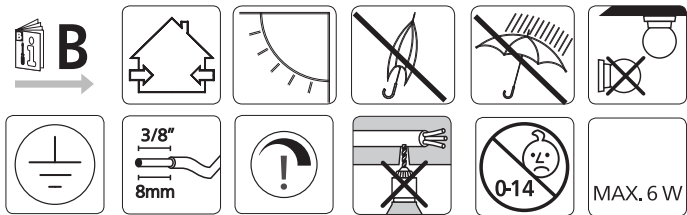

## **EN** IMPORTANT SAFETY INSTRUCTIONS

Product appearance may vary from image shown.

**CAUTION - RISK OF FIRE THIS PRODUCT MUST BE INSTALLED IN ACCORDANCE WITH THE APPLICABLE INSTALLATION CODE BY A PERSON FAMILIAR WITH THE CONSTRUCTION AND OPERATION OF THE PRODUCT AND THE HAZARDS INVOLVED. DANGER - RISK OF SHOCK - DISCONNECT POWER BEFORE INSTALLATION.** Always consult a professional in advance, for choosing the right fastener for a secure mounting of the product. Take into account the weight of the product and the material of the mounting surface. If in doubt, consult a qualified or licensed electrician or contact your retail outlet.

## **FR** MESURES DE SÉCURITÉ À RESPECTER

L'apparence du produit peut différer de l'image montrée.

**ATTENTION - RISQUE D'INCENDIE CE PRODUIT DOIT ÊTRE INSTALLÉ SELON LE CODE D'INSTALLATION PERTINENT? PAR UNE PERSONNE QUI CONNAÎT BIEN LE PRODUIT ET SON FONCTIONNEMENT AINSI QUE LES RISQUES INHÉRENTS. DANGER-RISQUE DE CHOC - COUPER L'ALIMENTATION AVANT L'INSTALLATION.** Consultez toujours un professionnel pour choisir l'attache adéquate pour une fixation sécurisée du produit. Prenez en compte le poids du produit et les matériaux de la surface de fixation. "En cas de doute, consultez un électricien qualifié ou sous licence ou contactez votre revendeur.

## **ES** INSTRUCCIONES DE SEGURIDAD IMPORTANTES

La apariencia del producto puede variar de la imagen mostrada.

**PRECAUCION- RIESGO DE INCENDIO ESTE PRODUCTOR DEBE SER INSTALADO SEGUN EL CODIGO DE INSTALACION APLICABLE POR UNA PERSONA QUE CONOZCA LA CONSTUSSION Y EL FUNCIONAMIENTO DEL PRODUCTO Y LOS RIESGOS QUE SUPONE. PELIGRO-RIESGO DE DESCARGA ELÉCTRICA - DESCONECTE LA ENERGÍA ANTES DE LA INSTALACIÓN.** Consulte siempre a un profesional para elegir el cierre adecuado para instalar el producto de forma segura. Tenga en cuenta el peso del mismo y el material de la superficie de montaje. En caso de duda, consulte a un electricista cualificado o autorizado o póngase en contacto con su distribuidor.

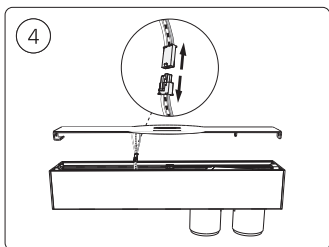
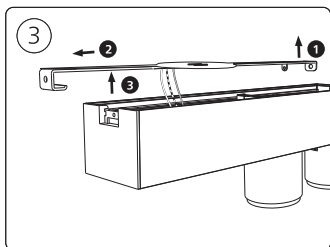
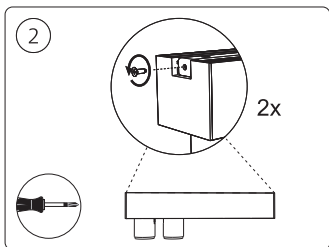
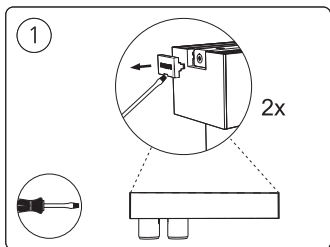
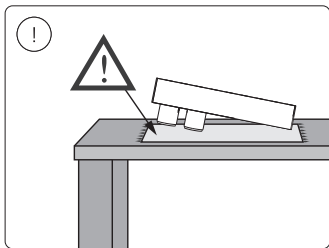
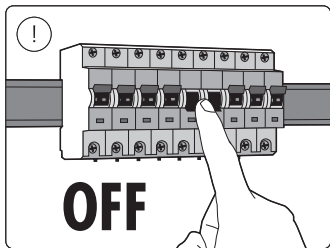

5

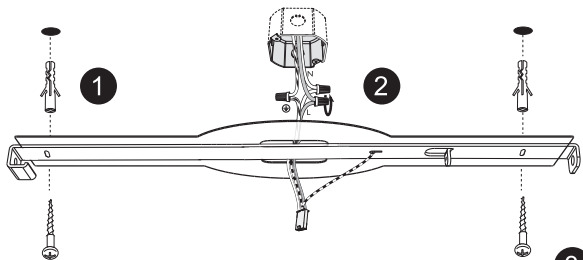
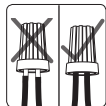

3



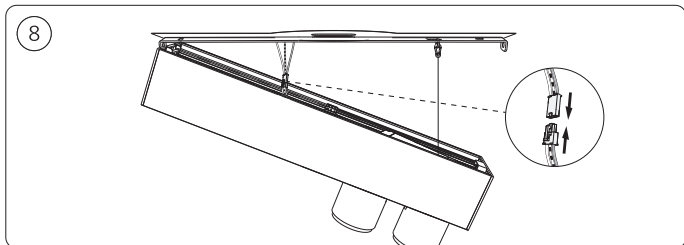
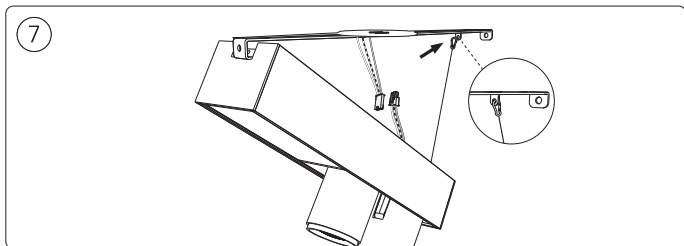
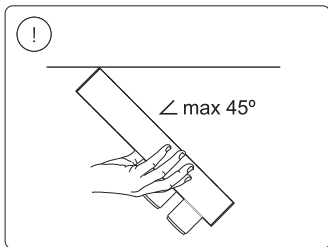
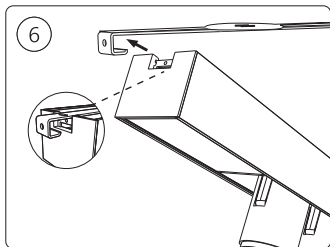

9a

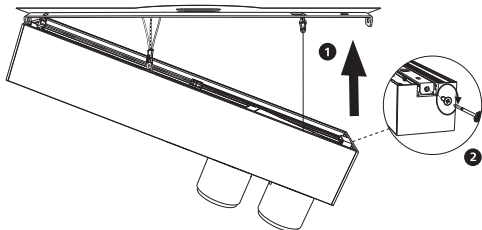

9b

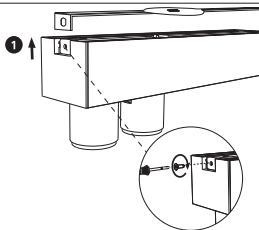

10

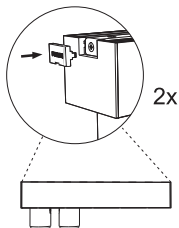



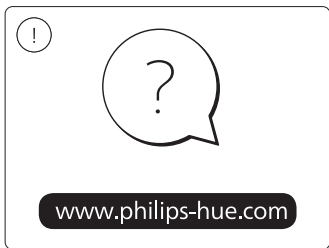
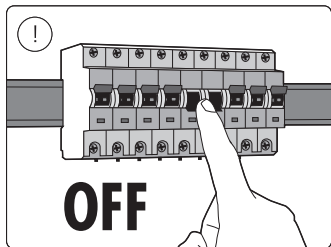

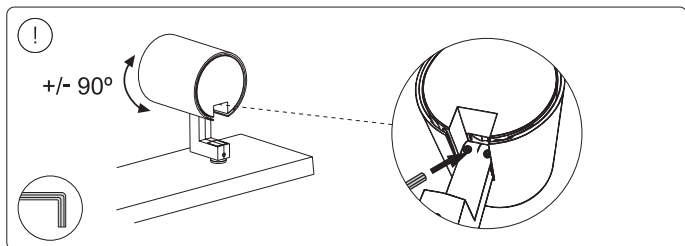
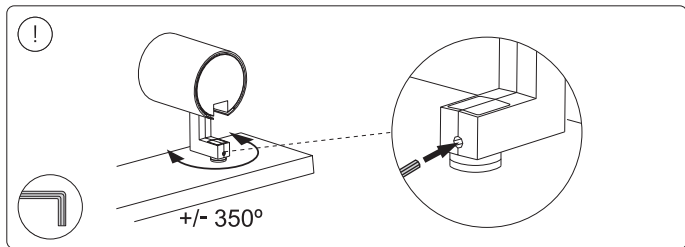

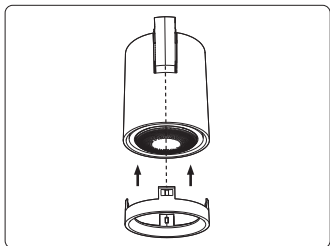
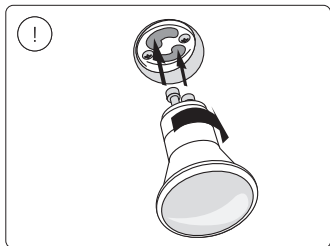
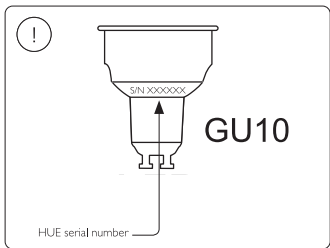
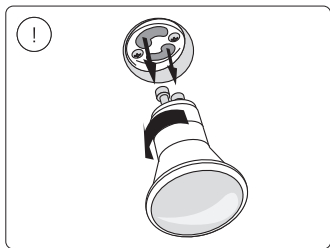
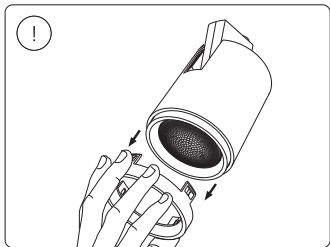



### **EN** Wire Connectors Instructions:

1. Turn off power before installing or removing connectors.
2. Strip wires 5/16" (7.9mm), For #16 and smaller wires, strip 3/8" (9.5mm).
3. Pre-twisting unnecessary, hold stripped wires together with ends even. Lead stranded wires slightly.
4. Align any frayed strands or conductors.
5. Push wires into connector and screw on until two twists are visible in wires.

For use with copper to copper conductor

Temperature Rating: 105°C (221 °F) Max.

Voltage Rating: 600V Max. building wiring; 1000V Max. in fixtures and signs

Listed as a PRESSURE-TYPE wire connector on the following Solid and /or Stranded wire combinations:

For UL Listed, CSA and CQC Certified

2#16

2 to 4#18

1#14 w/ 1#16

1#14 w/ 1#16 w/ 1#18

1#14 w/ 1 or 2#18

1#14 w/ 1 to 3#20 or #22

1#16 w/ 1 or 2#18

1#16 w/ 1#18 w/ 1#22

1#16 w/ 1 to 3#20 or #22

1 or 2#16 w/ 1#20 w/ 1#22

2#16 w/ 1#18

2#16 w/ 1 or 2#20

2#16 w/ 1 to 3#22

1#18 w/ 2 to 4#20

1#18 w/ 3 or 4#22

1 or 2#18 w/ 1#20 w/ 1#22

2#18 w/ 1 or 2#20 or #22

3#18 w/ 1#20 or #22

**FR Instructions de pose des connecteurs :**

1. Coupez le courant avant d'installer ou d'enlever les connecteurs.
2. Dénudez les fils de 7,9 mm (5/16 po). Pour les fils de calibre 16 et plus petits, dénudez de 9,5 mm (3/8 po).
3. Il n'est pas nécessaire de pré-torsader, tenez les fils dénudés ensemble avec les extrémités à égalité.  
Torsadez légèrement les fils toronnés (en brins).
4. Alignez tous les brins ou conducteurs effilochés.
5. Insérez les fils dans le connecteur et vissez jusqu'à ce que deux torsades soient visibles dans les fils.

Pour utilisation avec fils conducteurs de cuivre à cuivre

Température de service : 105 °C (221 °F) max.

Tension de service : 600 V max, pour le câblage de bâtiment; 1 000 V max, pour les appareils d'éclairage et les enseignes

Homologué en tant que connecteur de type à pression pour les combinaisons de fils massifs et toronnés suivantes :

Pour fils homologués UL, CSA et CQC

2#16	1#14 w/1 à 3#20 ou #22	2#16 w/1#18	1#18 w/3 ou 4#22
2 à 4#18	1#16 w/1 ou 2#18	2#16 w/1 ou 2#20	1 ou 2#18 w/1#20 w/1#22
1#14 w/1#16	1#16 w/1#18 w/1#22	2#16 w/1 à 3#22	2#18 w/1 ou 2#20 ou #22
1#14 w/1#16 w/1#18	1#16 w/1 à 3#20 ou #22	1#18 w/2 à 4#20	3#18 w/1#20 ou #22
1#14 w/1 ou 2#18	1 ou 2#16 w/1#20 w/1#22		

**ES Instrucciones para los conectores para alambres:**

1. Apague la alimentación eléctrica antes de instalar o quitar los conectores.
2. Pele 5/16" (7,9mm) de los alambres. Si los alambres son del #16 o más pequeños, pele 3/8" (9,5mm).
3. No es necesario torcerlos primero. Sostenga los alambres pelados juntos, con las puntas parejas.  
Enderece ligeramente los alambres torcidos.
4. Alinee todos los hilos o conductores que no estén chuecos.
5. Introduzca los alambres en el conector y atornille hasta que vea dos vueltas en los alambres.

Para uso con conductores de cobre

Temperatura máxima: 105°C (221 °F).

Tensión nominal: 600V máx. cableado de edificios; 1000V máx. en aparatos eléctricos y letreros

Clasificado como conector TIPOA PRESIÓN en las siguientes combinaciones de alambres sólidos y/o torcidos:

Para alambres con certificación UL Listed, CSA y CQC

2#16	1#14 w/1 a 3#20 o #22	2#16 w/1#18	1#18 w/3 o 4#22
2 a 4#18	1#16 w/1 o 2#18	2#16 w/1 o 2#20	1 o 2#18 w/1#20 w/1#22
1#14 w/1#16	1#16 w/1#18 w/1#22	2#16 w/1 a 3#22	2#18 w/1 o 2#20 o #22
1#14 w/1#16 w/1#18	1#16 w/1 a 3#20 o #22	1#18 w/2 a 4#20	3#18 w/1#20 o #22
1#14 w/1 o 2#18	1 o 2#16 w/1#20 w/1#22		







Signify North America Corporation  
400 Crossing Blvd, Suite 600 Bridgewater, NJ 08807, USA

Signify Canada Ltd./Signify Canada Ltée.  
281 Hillmount Road,  
Markham, ON, Canada L6C 2S3

Questions or Comments |  
Questions ou commentaires :  
1-800-555-0050

© 2024 Signify Holding  
All rights reserved

Last update: 01/2024

[www.philips-hue.com](http://www.philips-hue.com)

442296185762

