



CorePro LED PLC 2P



CorePro LED PLC 6.5W 840 2P G24d-2

De Philips CorePro LED PLC 2P is een LED-lichtbron in de vormfactor van een traditionele fluorescentielamp. Dit product vormt de ideale oplossing voor het opwaarderen van TL-verlichting in algemene verlichtingstoepassingen; het voldoet aan de basiseisen voor verlichting, biedt aanzienlijke energiebesparingen en is milieuvriendelijk.

Product gegevens

Algemene informatie	
Lampvoet	G24d-2
Nominale levensduur	30.000 hr
Schakelcyclus	50.000
Lamptype	LED
Meetreferentie van lichtstroom	Sphere
CE-markering	Ja
Conform EU RoHS-richtlijn	Ja

Gegevens lichttechniek	
Kleurcode	840 [CCT of 4000K]
Bundelhoek (nom.)	120 graden
Lichtstroom	700 lm
Kleuraanduiding	Koelwit (CW)
Gecorreleerde kleurtemperatuur (nom)	4000 K
Lichtrendement (gespec.) (nom.)	92,31 lm/W
Kleurconsistentie	<6
Kleurweergave-index (CRI)	83
LLMF bij einde nominale levensduur (nom.)	70 %
Photobiological safety according to EN 62471	RG0

Bedrijfs- en elektrische gegevens	
Ingangsfrequentie	50 to 60 Hz
Ingangsfrequentie	50 tot 60 Hz
Energieverbruik	6,5 W
Lampstroom (max.)	35 mA
Lampstroom (min.)	25 mA
Opstarttijd (nom.)	0,5 s
Opwarmtijd tot 60% licht	0,5 s
Arbeidsfactor	0,9
Spanning (nom.)	220-240 V
LED alternative to fluorescent lamp power	18 W
Aanloopstroom op netspanning	3,4
Max. lampnr. op MCB B type 10 A - netvoeding	123
Max. lampnr. op MCB B type 10 A – EM-voorschakelapparaat (VSA) zonder comp. cond.	150
Max. lampnr. op MCB B type 10 A – EM-voorschakelapparaat (VSA) met comp. cond.	30
Max. lampnr. op MCB B type 16 A - netvoeding	197
Max. lampnr. op MCB B type 16 A – EM-voorschakelapparaat (VSA) zonder comp. cond.	220

CorePro LED PLC 2P

Max. lampnr. op MCB B type 16 A – EM-voorschakelapparaat (VSA) met comp. cond.	49
Operationele temperatuur	
Omgevingstemperatuurbereik	-20 °C t/m 35 °C
T-behuizing maximaal (nom.)	65 °C
Dimbaarheid en regelsystemen	
Dimbaar	Nee
Eigenschappen behuizing en afmetingen	
Lampmateriaal	Kunststof
Productlengte	100 mm
Lampvorm	PL-C
Keurmerken en classificaties	
Energie-efficiëntielabel	F
Energiebesparend product	Ja
Keurmerken	TÜV CE-markering Conform RoHS KEMA Keur-certificaat

Energieverbruik kWh/1.000 uur	7 kWh
EPREL-registratienummer	403557
Productgegevens	
Productnaam voor bestelling	CorePro LED PLC 6.5W 840 2P G24d-2
Volledige productnaam	CorePro LED PLC 6.5W 840 2P G24d-2
Full EOC	871869654129600
Bestelcode	8718696541296
Materiaalnr. (12NC)	929001201502
Lokale code	CPLC6.5W840D2
Numerator - Aantal per pak	1
EAN/UPC - product/behuizing	8718696541296
Numerator - Dozen per buitendoos	10
EAN/UPC - Case	8718696541302

Maatschets

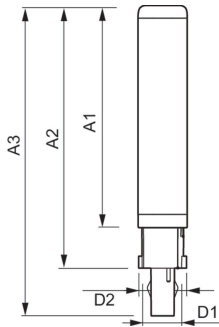

Product	D1	D2	A1	A2	A3
CorePro LED PLC 6.5W 840 2P G24d-2	24,3 mm	28,4 mm	105,8 mm	125 mm	147,6 mm

Fotometrische gegevens

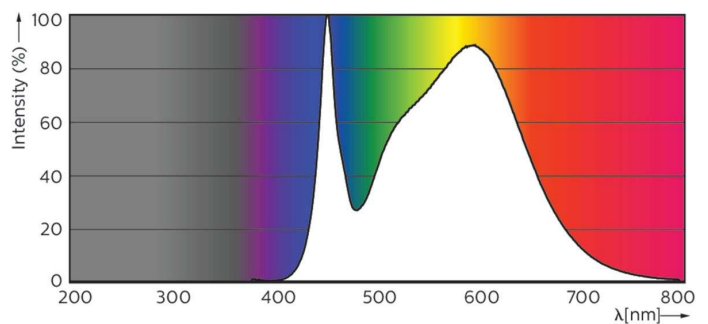
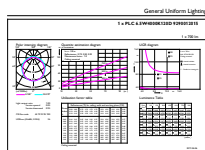

General uniform lighting - CorePro LED PLC 6.5W 840 2P G24d-2

Spectral Power Distribution Colour - CorePro LED PLC 6.5W 840 2P G24d-2

CorePro LED PLC 2P

Fotometrische gegevens

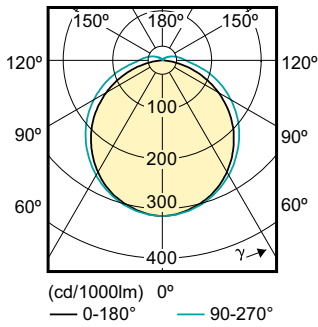

Light Distribution Diagram - CorePro LED PLC 6.5W 840 2P G24d-2

Levensduur

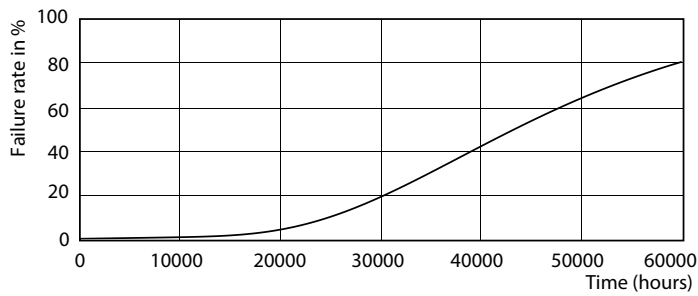

Life Expectancy Diagram - CorePro LED PLC 6.5W 840 2P G24d-2

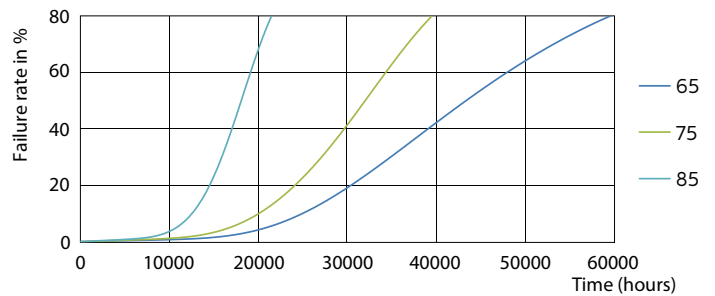

Life Expectancy Diagram - CorePro LED PLC 6.5W 840 2P G24d-2

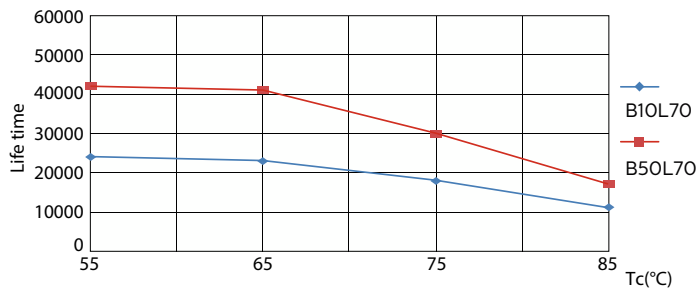

Life Expectancy Diagram - CorePro LED PLC 6.5W 840 2P G24d-2

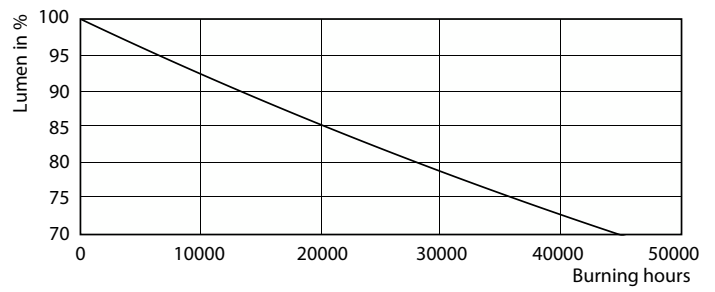

Lumen Maintenance Diagram - CorePro LED PLC 6.5W 840 2P G24d-2

CorePro LED PLC 2P

Levensduur

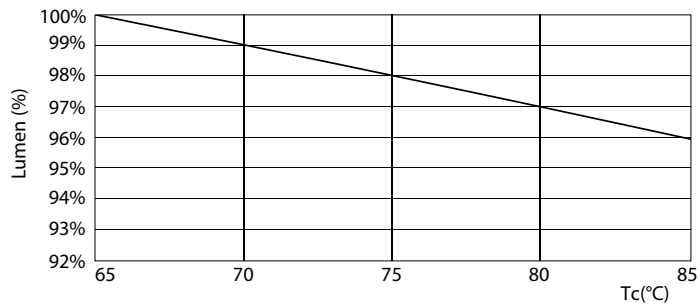

Lumen Maintenance Diagram - CorePro LED PLC 6.5W 840 2P G24d-2

