



# CorePro LED PLC 4P



## CorePro LED PLC 6.5W 840 4P G24q-2

De Philips CorePro LED PLC 4P is een LED-lichtbron in de vorm van een traditionele fluorescentielamp. Dit product vormt de ideale oplossing voor het opwaarderen van TL-verlichting in algemene verlichtingstoepassingen: het voldoet aan de basiseisen voor verlichting, biedt aanzienlijke energiebesparingen en is milieuvriendelijk.

### Product gegevens

Algemene informatie	
Lampvoet	G24q-2
Nominale levensduur	30.000 hr
Schakelcyclus	50.000
Lamptype	LED
Meetreferentie van lichtstroom	Sphere
CE-markering	Ja
Conform EU RoHS-richtlijn	Ja

Gegevens lichttechniek	
Kleurcode	840 [CCT of 4000K]
Bundelhoek (nom.)	120 graden
Lichtstroom	700 lm
Kleuraanduiding	Koelwit (CW)
Gecorreleerde kleurtemperatuur (nom)	4000 K
Lichtrendement (gespec.) (nom.)	92,31 lm/W
Kleurconsistentie	<6
Kleurweergave-index (CRI)	83
LLMF bij einde nominale levensduur (nom.)	70 %
Photobiological safety according to EN 62471	RG0

Bedrijfs- en elektrische gegevens	
Ingangsfrequentie	30000-80000 Hz

Ingangsfrequentie	30000-80000 Hz
Energieverbruik	6,5 W
Lampstroom (max.)	300 mA
Lampstroom (min.)	150 mA
Opstarttijd (nom.)	0,5 s
Opwarmtijd tot 60% licht	0,5 s
Arbeidsfactor	0,9
Spanning (nom.)	20-50 V
LED alternative to fluorescent lamp power	18 W
Aanloopstroom op netspanning	-
Max. lampnr. op MCB B type 10 A - netvoeding	-
Max. lampnr. op MCB B type 10 A – EM-voorschakelapparaat (VSA) zonder comp. cond.	-
Max. lampnr. op MCB B type 10 A – EM-voorschakelapparaat (VSA) met comp. cond.	-
Max. lampnr. op MCB B type 16 A - netvoeding	-
Max. lampnr. op MCB B type 16 A – EM-voorschakelapparaat (VSA) zonder comp. cond.	-
Max. lampnr. op MCB B type 16 A – EM-voorschakelapparaat (VSA) met comp. cond.	-

Operationele temperatuur	
Omgevingstemperatuurbereik	-20 °C t/m 35 °C

# CorePro LED PLC 4P

T-behuizing maximaal (nom.)	66 °C
<b>Dimbaarheid en regelsystemen</b>	
Dimbaar	Nee
<b>Eigenschappen behuizing en afmetingen</b>	
Productlengte	100 mm
Lampvorm	PL-C
<b>Keurmerken en classificaties</b>	
Energie-efficiëntielabel	F
Energiebesparend product	Ja
Keurmerken	TÜV CE-markering Conform RoHS KEMA Keur-certificaat
Energieverbruik kWh/1.000 uur	7 kWh
EPREL-registratienummer	403553

## Productgegevens

Productnaam voor bestelling	CorePro LED PLC 6.5W 840 4P G24q-2
Volledige productnaam	CorePro LED PLC 6.5W 840 4P G24q-2
Full EOC	871869654121000
Bestelcode	8718696541210
Materiaalnr. (12NC)	929001201102
Lokale code	CPLC6.5W840Q2
Numerator - Aantal per pak	1
EAN/UPC - product/behuizing	8718696541210
Numerator - Dozen per buitendoos	10
EAN/UPC - Case	8718696541227

## Maatschets

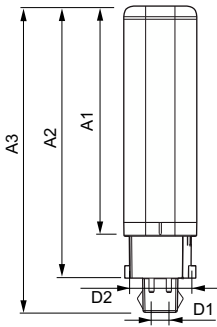

Product	D1	D2	A1	A2	A3
CorePro LED PLC 6.5W 840 4P G24q-2	24,3 mm	28,4 mm	105,8 mm	125 mm	140,6 mm

## Fotometrische gegevens

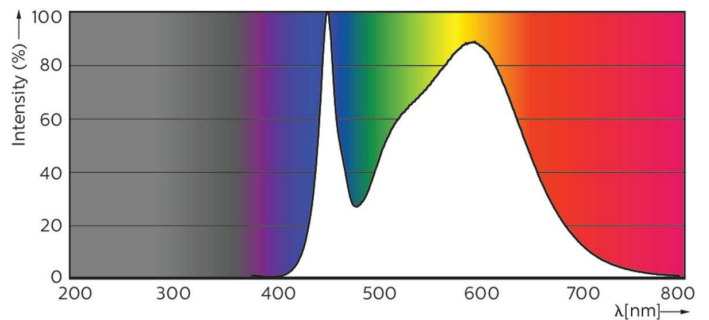
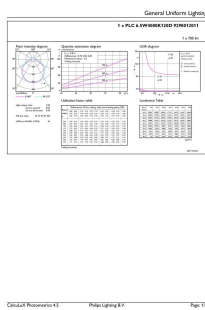

General uniform lighting - CorePro LED PLC 6.5W 840 4P G24q-2

Spectral Power Distribution Colour - CorePro LED PLC 6.5W 840 4P G24q-2

# CorePro LED PLC 4P

## Fotometrische gegevens

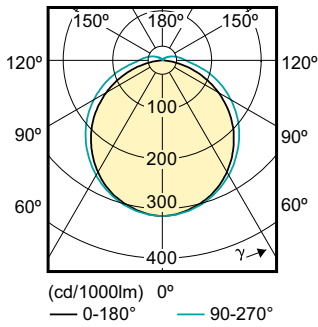

Light Distribution Diagram - CorePro LED PLC 6.5W 840 4P G24q-2

## Levensduur

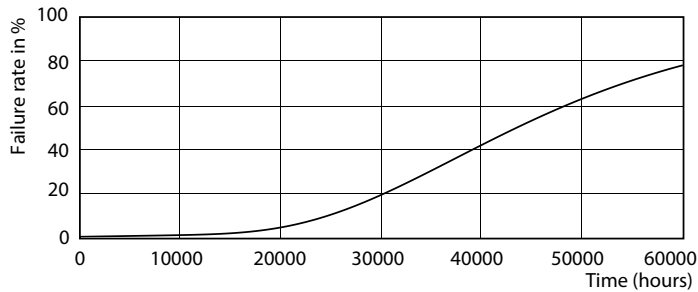

Life Expectancy Diagram - CorePro LED PLC 6.5W 840 4P G24q-2

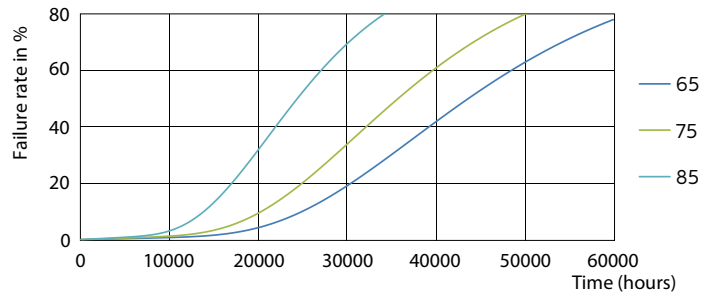

Life Expectancy Diagram - CorePro LED PLC 6.5W 840 4P G24q-2

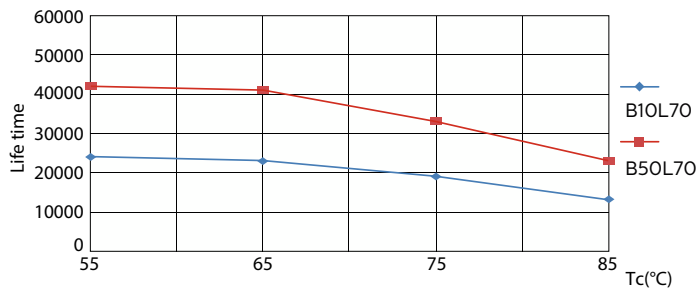

Life Expectancy Diagram - CorePro LED PLC 6.5W 840 4P G24q-2

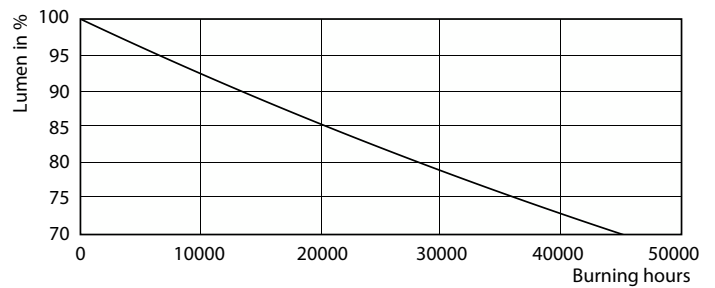

Lumen Maintenance Diagram - CorePro LED PLC 6.5W 840 4P G24q-2

# CorePro LED PLC 4P

## Levensduur

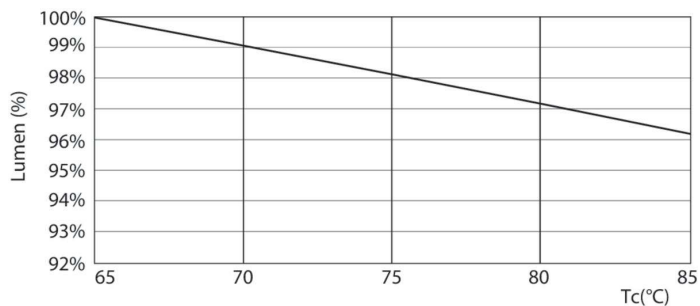

Lumen Maintenance Diagram - CorePro LED PLC 6.5W 840 4P G24q-2

