

CHLORIDE

by  Signify

UNIVERSAL RECESSED / SURFACE MOUNT LED EXIT SIGN

EMERGENCY BATTERY BACKUP

INSTALLATION & OPERATION INSTRUCTIONS

Package Contents

Part	Description	Quantity
1	LED Edge-Lit EXIT Sign	1
2	Adjust Bracket and Bar hanger	2
3	Hardware Bag	1

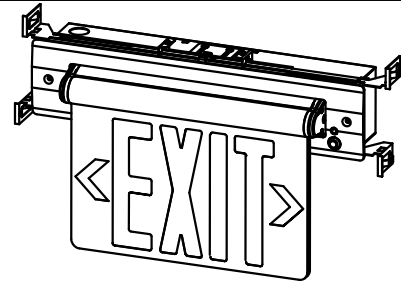

Warnings and Cautions

IMPORTANT SAFEGUARDS

READ AND FOLLOW ALL SAFETY INSTRUCTIONS.

1. Review the diagrams thoroughly before beginning. If you feel you do not have electrical wiring experience, refer to a do-it yourself wiring handbook or have your fixture installed by a qualified licensed electrician.
2. All electrical connections must be in accordance with local codes, ordinances, and the National Electric Code. If you are unfamiliar with methods from installing electrical wiring, secure the services from a qualified licensed electrician.
3. Before starting the installation, disconnect the power by turning off the circuit breaker or by removing the appropriate fuse at the fuse box. Using the light switch to turning the power off is not sufficient to prevent electrical shock.
4. Do not use outdoors.
5. Do not let power supply cords touch hot surfaces.
6. Do not mount near gas or electric heaters.
7. Use caution when servicing batteries. Battery acid can cause burns to skin and eyes. If acid is spilled on skin or eyes, flush acid with fresh water and contact a physician immediately.
8. Equipment should be mounted in locations and at heights where it will not be subjected to tampering by unauthorized personnel.
9. The use of accessory equipment not recommended by the manufacturer may cause an unsafe condition.
10. Do not use this equipment for other than its intended use.
11. All servicings should be performed by a qualified personnel only.
12. Allow battery to charge for 24 hours before first use.

SAVE THESE INSTRUCTIONS

ELECTRICAL CONNECTIONS

- Make the proper supply wire connections.
- If using 120VAC, connect the black and white wires to the building utility.
- If using 277VAC, connect the orange and white wires to the building utility.
- Cap off unused wires. In all cases, use standard wire nuts in connection to wires.

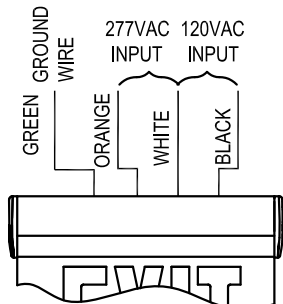

DETERMINE DIRECTION

- If need indicator, remain indicator and remove instruction film.
- If no need indicator, remove indicator and instruction film together.



Mounting Instructions

NOTE: First turn off electricity.

Recessed Ceiling Mounting

1. Refer to assembly drawing before you start installation.
2. Use screwdriver open front cover and connect battery connector .

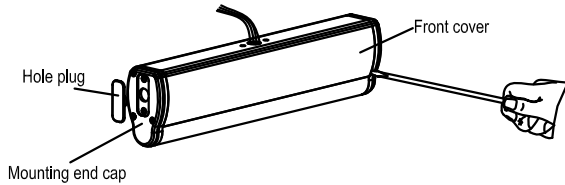

3. Position recessed kits and bar hangers between joists. Make sure bar hangers to be hanged in the correct position. Position recessed kits temporarily by hammering "nail-in" tabs on bar hangers, then secure permanently with nails. Bar hangers should be level with bottom of joists .
4. Adjust height of recessed kits vertically using adjusting slots and then tightening all screws on adjusting slots and bar hanger bracket to secure adjusting bracket and bar hangers .

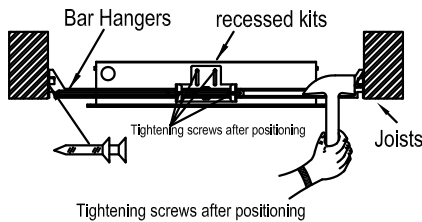

5. Make proper electrical connections at J-box in the metal box or at junction box in the ceiling of building . If using 120VAC, connect black and white leads to the building utility. If using 277VAC, connect orange and white leads to the building utility . Cap off unused wire. In all cases, use standard wire nuts in connection to leads. You may use holding wire during wiring .

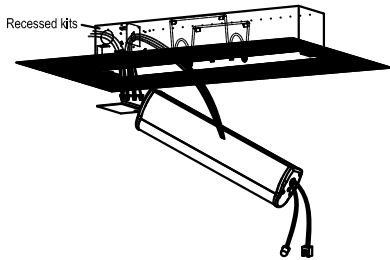

6. Connect test switch and LED indicator cables via connectors.
7. Secure trim plate by using provided screws.

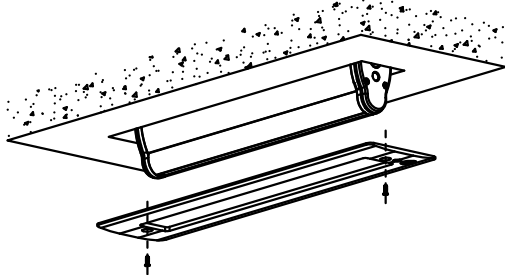

8. Insert EXIT panel into main body assembly gently. If EXIT panel is for single face, make sure EXIT letter direction is right.

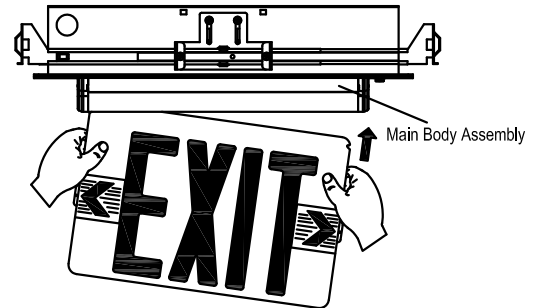

9. Determine direction for chevron placement. (See DETERMINE DIRECTION)
10. The unit can be installed on any surface, you may rotate the EXIT panel in any angle from 0° to 180°

Recessed Wall Mounting

1. Reference 1 - 10 step in recessed ceiling mounting above for recessed wall mounting.
2. Recessed ceiling mounting rotate 90° become recessed Wall mounting.

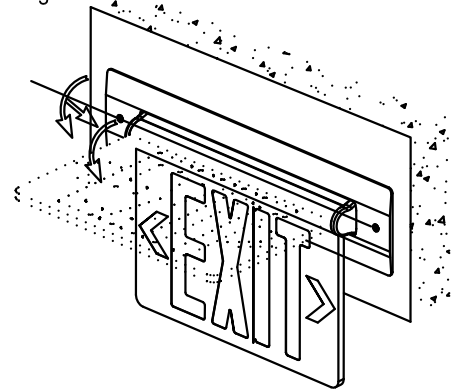

Assembly Drawing

